



# PRODUCT CATALOG

AVANTES

EMPOWERING SPECTROSCOPY SOLUTIONS

# INTRODUCTION

---

Get ready to dive into Avantes' solutions, where precision meets innovation and endless possibilities await. We are thrilled to present the Avantes Product Catalog, a bundle of cutting-edge spectroscopic solutions designed to elevate your experiments and research.

In these pages, you'll discover a vast array of high-quality spectrometers, light sources, fiber optics, software, and accessories carefully crafted to meet the diverse needs of researchers, scientists, and engineers across industries. Whether you're delving into the fascinating world of fiber-optic spectroscopy or seeking advanced tools for accurate measurements, Avantes has you covered.

Our commitment to excellence drives us to continuously push the boundaries of spectroscopic technology. With over three decades of experience in fiber-optic spectroscopy and an impressive global presence, Avantes stands as a beacon of trust and reliability in the field.

In this catalog, you'll find detailed information about our state-of-the-art spectrometers, featuring cutting-edge CCD and CMOS detectors that revolutionize how we scan spectra. Witness the ingenuity of our AvaSpec line, offering fast and precise scanning without the need for moving parts.

But that's not all. Avantes accessories open up a world of possibilities, providing seamless integration and enhancing the versatility of our spectrometers. From cuvette holders and integrating spheres to fiber-optic multiplexers and flow cells, our range of accessories is designed to meet your specific experimental requirements.

We understand that every scientific journey is unique, and that's why we offer a modular approach, empowering you to tailor your spectroscopic setup to your exact needs. With Avantes, you'll have the flexibility and tools for your application or research and achieve remarkable results.

Thank you for choosing Avantes as your partner in the world of spectroscopy. Let's begin this adventure together, one wavelength at a time!

Pierre Warffemius - CEO Avantes B.V.



## Disclaimer and Copyright

The information in this catalog, including (among others) drawings, illustrations, schematics, values and measured values, specifications, data, and technical data, from now on referred to as the information, is believed to be reliable, and all specifications are valid. However, Avantes makes no guarantees as to the accuracy and/or the completeness of the content of the information, and Avantes disclaims any liability arising from and/or in connection with the content and the use of the information. Avantes' liability for the content and the use of the information is excluded. Avantes will be exempted from any claim arising from and/or in connection with the content and the use of the information. No part of this catalog may be reproduced or copied in any form or by any means without prior written permission from Avantes.

Copyright © Avantes BV, 2023

# ABOUT AVANTES

---

We are Avantes, a leading manufacturer of fiber-optic spectroscopy instruments and systems where cutting-edge technology meets precision and reliability. Our wide range of products caters to various industries, including (bio)medical, agriculture, semiconductor, and consumer electronics, empowering researchers and professionals worldwide.

## **Empowering Spectroscopy Solutions**

Our compact spectrometer systems are carefully designed to enable research and industrial measurements involving the metrology of light. Covering ultra-violet, visible, and near-infrared wavelengths (200-2500 nm), our instruments provide unparalleled accuracy for a multitude of applications.

## **Discover Innovation and Vision**

At Avantes, our vision is to enrich the lives of humankind in the world we live in. With state-of-the-art, innovative measuring equipment, we strive to foster longer, healthier lives and positively impact the planet for generations to come.

## **Your Trusted Partner**

With nearly 30 years of experience, we have a rich history of collaborating with clients across diverse industries and applications across the globe. Our dedicated sales engineers are equipped to guide you in finding tailor-made solutions for your unique research and measurement needs.

## **Global Reach, Local Support**

Headquartered in Apeldoorn, the Netherlands, all our products are designed, developed, and manufactured to the highest standards. We also have direct offices in Colorado, United States, and two locations in China, ensuring local support for our international customers.

## **Exclusive Distributor Network**

In addition to our direct offices, we have partnered with exclusive distributors in over 35 countries. Their expertise in configuring and utilizing our spectroscopy solutions guarantees prompt assistance whenever and wherever you need it.

## **Let's Innovate Together**

We invite you to explore our comprehensive product catalog and join us on a journey of discovery, innovation, and excellence in spectroscopy. Let Avantes be your trusted partner in advancing scientific research and technological breakthroughs. Together, we can create a brighter future for all.



EMPOWERING **SPECTROSCOPY** SOLUTIONS

## SPECTROMETERS

6

Introduction	6
Spectrometer Lines Overview	8
AvaSpec Preconfigured Spectrometers (In Stock)	9
AvaSpec-NEXOS 2K	10
AvaSpec-NEXOS 4K	11
AvaSpec-NEXOS Link	12
AvaSpec-Mini2048CL	13
AvaSpec-Mini4096CL	14
AvaSpec-Mini-NIR	15
AvaSpec-VARIUS 2K	16
AvaSpec-VARIUS 4K	17
AvaSpec-VARIUS OEM	18
AvaSpec-ULS2048CL-EVO	19
AvaSpec-ULS4096CL-EVO	20
Replaceable Slit Spectrometer	21
AvaSpec-ULS2048XL-EVO	22
AvaSpec-HERO	23
AvaSpec-ULS2048x64TEC-EVO	24
AvaSpec-HS2048XL-EVO	25
AvaSpec-ULS2048x64-EVO	26
AvaSpec-NIR256/512-1.7-EVO	27
AvaSpec-NIR256/512-1.7-HSC-EVO	28
AvaSpec-NIR256/512-2.5-HSC-EVO	29
AvaSpec Multi-Channel Spectrometer	30
AvaSpec Dual-Channel Spectrometer	31
Avantes Raman Bundles	32
AvaRaman Raman System	33
Raman Probes and Accessories	34
OEM Spectrometer: AS-7010 Microprocessor board	35
OEM Spectrometer: AvaBench Optical Bench	36
OEM Spectrometer: AvaBench NIR Optical Bench	37
Developer Kits for Easy IO Access	38
OEM Spectrometer: Enclosures	39
AvaSpec Spectrometer Interface Cables	40
Services and Calibrations AvaSpec Spectrometers	41

## SOFTWARE

42

Introduction	42
AvaSoft-Basic Software	44
AvaSoft-Full and AvaSoft-All	45
Panorama Spectroscopy Software	46
Specline Analytical Software	47
Interface Packages and Libraries for Windows and Linux	48

## LIGHT SOURCES

50

Introduction	50
AvaLight-HAL-(S)-MINI	52
AvaLight-DHc	53
AvaLight-DH-S	54
AvaLight-DH-S-BAL	55
AvaLight-XE	56
AvaLight-XE-HP	57
AvaLight-HPLED	58
AvaLight-HAL-CAL-Mini and AvaLight-DH-CAL	59
AvaLight-CAL	61

## FIBER OPTICS

62

Introduction	62
Fiber Optic Probe Properties	64
Fiber Optic Cables	65
Multi-Furcated Fiber Optic Cables	66
Reflection Probes (standard)	67
Reflection Probes with Multiple Legs	68
Reflection Probes with Reference	69
Reflection Probes with Small Tips	70
Reflection Probes for Powders and Thick Fluids	71
1/2" Industrial Reflection Probes for Powders and Thick Fluids	72
1/2" Industrial Fluorescence Probes	73
Mini Transmission Dip Probes	74
Transmission Dip Probes	75
Transmission Dip Probes with Variable Path Length	76
Custom Fiber Assemblies and Probes	77
Collimating Lenses	78
Cosine Correctors	79
Vacuum Feedthroughs	80
Fiber Optic Homogenizer	81
Fiber Microscope Adapters	82
Reflection Probe Holders	83
Transmission and Reflection Stage	84
Fiber Interconnects	85

## ACCESSORIES

86

Introduction	86
Cuvette Sample Holders	88
Temperature-Controlled Cuvette Holders	89
Slit Kit - Replaceable Slits	90
Direct-Attach Variable In-Line Filter Holder	91
Direct-Attach Cuvette Holders	92
Direct-Attach Fiber Optic Attenuator	93
Cuvette Holder with Attenuator and Filter Holder	94
Variable In-Line Filter Holder	95
In-Line Fiber-Optic Attenuator	96
Variable Pathlength Cuvette Holder	97
Integrating Spheres	98
Integrating Sphere with Internal Halogen Light Source	99
Large Integrating Spheres	100
Variable Collimating Lens Holder	101
AvaTripod	102
AvaTrigger External Trigger Box	103
Fiber Optic Switch (FOS)	104
Direct-Attach Shutter	105
Fiber Optic Multiplexer (FOM)	106
Direct-Attach Beam-Splitter Combiner	107
In-Line Flow Cells	108
Micro Flow Cell	109
Reference Tiles	110
12 and 24 Volts Power Adapters for Spectrometers and Light Sources	111

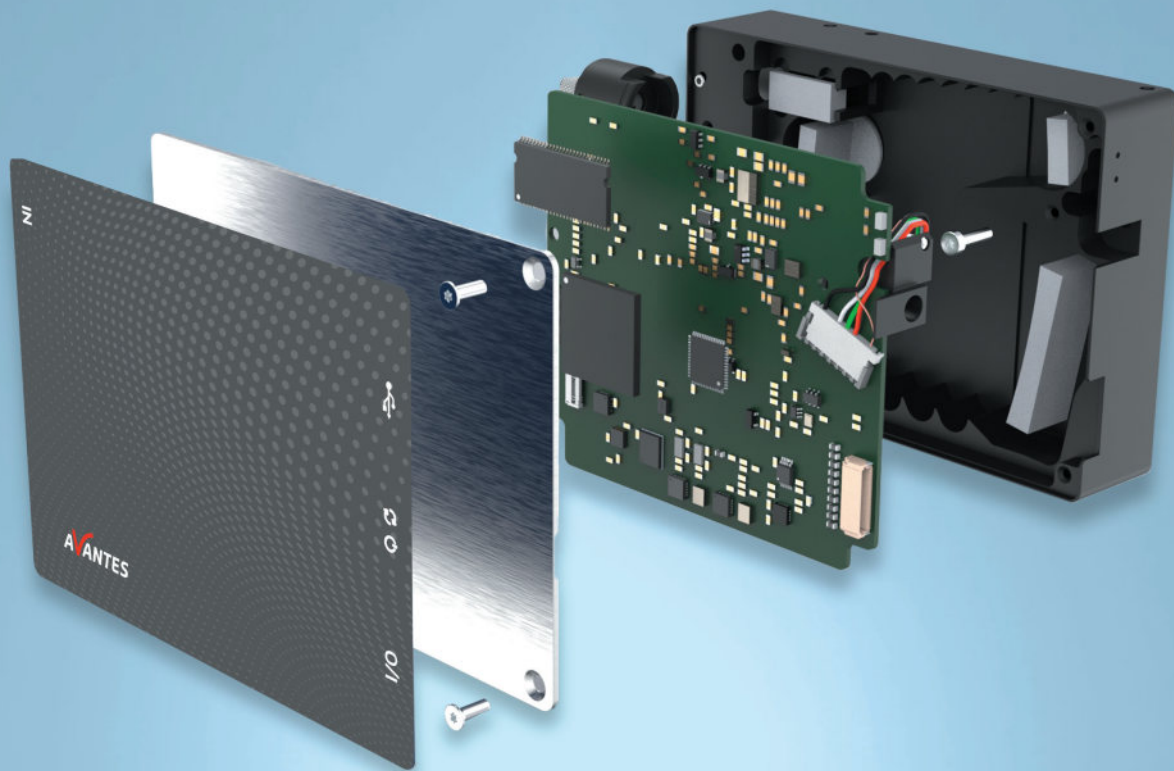

# SPECTROMETERS

## INTRODUCTION

Welcome to the world of Avantes, where excellence in spectroscopic instrumentation is redefined. Our diverse range of spectrometers and spectroscopic instruments is thoughtfully engineered to cater to a wide array of applications across various industries. Join us as we embark on a journey through our innovative offerings.

At the heart of every Avantes spectrometer lies a sophisticated optical bench design, incorporating essential components such as an entrance slit, collimator, dispersive element (grating/prism), focusing optics, and a cutting-edge detector. This thoroughly crafted setup ensures precision and reliability in all our measurements.

# OUR TECHNOLOGY

Traditionally, spectrometers relied on moving gratings to scan the spectrum. However, Avantes revolutionized the field during the 1990s by adopting microelectronics, specifically Charged Coupled Devices (CCD) arrays and complementary metal-oxide-semiconductor (CMOS) detectors. This groundbreaking integration paved the way for our AvaSpec line of spectrometers, known for their fast and accurate scanning capabilities without the need for moving parts. Now, our customers can benefit from efficient and low-cost scanning thanks to these advanced CCD and CMOS detectors integrated into our spectrometers.

One of the cornerstones of Avantes' success in spectroscopy is the application of fiber optics technology. We leveraged the developments in low-absorption silica fibers, initially utilized in communication technology, and transformed them into measurement fibers that transport light from the sample to the optical bench of our spectrometers. The ease of coupling fibers empowers the creation of a versatile modular system encompassing a light source, various sampling accessories, and the fiber-optic spectrometer. This adaptability makes Avantes spectrometers the go-to choice for measurements in harsh and difficult-to-access environments, extending their usability to a broad spectrum of industries and applications.

The fusion of modularity, flexibility, and rapid measurement capabilities has led to the widespread adoption of Avantes fiber-optic spectrometers across industries. These instruments have become indispensable tools for researchers, scientists, and engineers worldwide, propelling innovation and discovery in diverse fields. Our spectrometers cover a wide range of wavelengths, from the ultraviolet to the visible and near-infrared regions. From chemical composition and quantification to color measurement and radiometry, Avantes spectrometers cater to the most demanding applications, empowering our customers to tackle their unique challenges confidently.

At the core of most AvaSpec fiber-optic spectrometers is a state-of-the-art optical bench design featuring a toroid mirror that ensures the full numerical aperture of the fiber entrance is projected onto a back-thinned CCD, CMOS, or InGaAs detector. These optical benches are carefully equipped with various components, providing many configuration options to meet the specific needs of each application. Critical choices, such as the type of diffraction grating, entrance slit, and order-sorting filter, play a pivotal role in determining system specifications like sensitivity, resolution, bandwidth, and stray light levels, ensuring that our spectrometers deliver unparalleled performance.

In conclusion, Avantes is your gateway to advanced spectroscopy solutions, enabling precise and reliable measurements across diverse industries. Our dedication to innovation and our passion for excellence continue to drive us forward, pushing the boundaries of what spectroscopy can achieve.

## TECHNICAL BACKGROUND SPECTROMETERS



Click [here](#) or scan the QR code to read all about our optical bench design, gratings, detectors, stray light, configuring a spectrometer, and much more.

**WE OFFER THREE YEARS  
LIMITED WARRANTY ON  
ALL AVANTES SPECTRO-  
METERS, LIGHT SOURCES,  
AND ACCESSORIES.**



## Spectrometer Lines

At Avantes, we understand that spectroscopy is a diverse and dynamic field with many applications requiring tailored solutions. That's why we've categorized our spectrometers into distinct lines, each specifically engineered to excel in different areas of spectroscopic exploration. Join us as we take you through our four spectrometer lines.

### CompactLine: Size Meets Performance

When space is a precious commodity, the CompactLine delivers impressive performance in a small form factor. Our CompactLine boasts one of the smallest spectrometers on the market without compromising resolution or speed. With multiple configurations available, these miniature spectrometers are perfect for various applications across industries. Thanks to our AvaMation production process, unit-to-unit reproducibility is guaranteed. Compact, efficient, and powerful, the CompactLine spectrometers integrate seamlessly into OEM and handheld devices.



### StarLine: Versatility Redefined

The AvaSpec StarLine family is a high-performance lineup of spectrometers designed to exceed the demands of general spectroscopy applications. With a wide array of solutions and excellent price-to-performance ratios, our Varius, AvaSpec-ULS2048CL-EVO and AvaSpec-ULS4096CL-EVO, equipped with CMOS arrays, cover wavelengths from 200 to 1100 nm. These spectrometers shine in a variety of applications, including reflection and transmission measurements, irradiance and emission studies, high-speed measurements, and absorbance chemistry. Fully integrated into Avantes' modular platform, they effortlessly function as standalone or multi-channel instruments, offering exceptional versatility for your experiments.

### SensLine: For the Most Demanding Applications

Our AvaSpec SensLine is dedicated to higher performance and sensitivity, catering to challenging spectroscopy applications like fluorescence, luminescence, and Raman. Featuring back-thinned detector technology and advanced thermoelectric cooling, these high-sensitivity, low-noise spectrometers deliver outstanding results. The SensLine boasts a range of detectors with excellent quantum efficiency across the ultraviolet, visible, and near-infrared range (200 to 1160 nm). These spectrometers offer precision without compromise with features like high stability, sensitivity, speed, and low noise. Avantes' innovative optical benches (ULS, HS, and HSC) ensure high-performing instruments at affordable prices, opening doors to a world of scientific possibilities.



### NIRLine: Unleashing the Power of Near-Infrared

For measuring long wavelengths, the AvaSpec NIRLine is the ultimate choice. These spectrometers come equipped with a toroidal focusing mirror and dynamic dark correction for enhanced stability. The NIRLine boasts thermoelectrically cooled and uncooled instruments featuring InGaAs detectors with exceptional performance. From moisture content measurement and plastic characterization to solar monitoring and material identification, the NIRLine is the pinnacle of near-infrared spectroscopy. Compatible with our StarLine and SensLine spectrometers, the NIRLine offers seamless integration into your existing systems.

In each Avantes spectrometer line, you'll find an exceptional combination of performance, reliability, and innovation. We aim to empower your spectroscopic journey, unlocking the true potential of your experiments and research. As you explore the following pages, get ready to witness the possibilities that await with Avantes spectrometers, your gateway to precision and discovery in the world of spectroscopy.



# Preconfigured Spectrometers

For customers with urgent needs and general flexibility in their specifications, Avantes offers a variety of preconfigured spectrometers. We keep these spectrometers in stock so they are readily available, which makes for a significant decrease in shipping time. Out of the six available models, four are configured to be used for measurements in the UV-VIS-NIR range (200 to 1100 nm), one for the VIS-NIR range (360 to 1100 nm), and one just for the visible range (360 to 880 nm).

Several models are equipped with a replaceable slit (RS). All preconfigured spectrometers are available at discount pricing and include an upgrade to AvaSoft-Full. The full specifications are listed below.

Name	AvaSpec- ULS2048CL- EVO-RS-UA	AvaSpec- ULS2048XL- EVO-RS-UA	AvaSpec- ULS4096CL- EVO-UA-10	AvaSpec- ULS2048CL- EVO-UA-50	AvaSpec- ULS2048CL- EVO-VA-50	AvaSpec- ULS2048CL- EVO-RS-BB
Uses	UV/VIS/NIR				VIS/NIR	VIS
Range	200 - 1100 nm	200 - 1160 nm	200 - 1100 nm		360 - 1100 nm	360 - 880 nm
Slit/Connector	25 µm/SMA-RS		10 µm SMA-905	50 µm/SMA-905		25 µm/SMA-RS
Resolution (FWHM)	1.4 nm		0.5-0.7 nm	2.5 nm		0.7 nm
A/D Convertor	16 bit					
Interface	USB 3.0/ETH					
Included options	Detector collecting lens, order-sorting coating, slit kit SMA		Detector collecting lens, order sorting coating, slit			Detector collecting lens, order-sorting coating, slit kit SMA
Applications	Absorbance, emission, irradiance measurements	High-sensitivity applications (fluorescence, irradiance from very low intensity sources)	High-resolution measurements from high-intensity sources (lasers, powerful light sources, plasma)	Absorbance, emission, irradiance measurements	Color measurements, visible irradiance measurements	
AvaSoft-Full	Included					

## Ordering Information

<b>AvaSpec-ULS2048 CL-EVO-RS-UA</b>	Ultra-low stray light fiber-optic UV/VIS/NIR spectrometer with replaceable slit, 2048 pixel/14x200 µm CMOS detector, grating UA (200-1100 nm), DCL-UV/VIS-200, OSC-UA, USB3 powered, high speed USB3 and ETH interface. Includes AvaSoft-Full and slit kit SMA (slit 25-RS preinstalled; 50, 100 and 200 µm in box).
<b>AvaSpec-ULS2048 XL-EVO-RS-UA</b>	Ultra-low stray light fiber-optic UV/VIS/NIR spectrometer with replaceable slit, 2048 pixel/14x500 µm back thinned CCD detector, grating UA (200-1100 nm), DCL-UV/VIS-200, OSC-UA, USB3 powered, high speed USB3 and ETH interface. Includes AvaSoft-Full and slit kit SMA (slit 25-RS preinstalled; 50, 100 and 200 µm in box).
<b>AvaSpec-ULS4069 CL-EVO-UA-10</b>	Ultra-low stray light fiber-optic UV/VIS/NIR spectrometer, 4069 pixel CMOS detector, slit 10, grating UA (200-1100 nm), OSC-UA, DCL-UV/VIS-200, USB3 powered, high speed USB3 and ETH interface. Includes AvaSoft-Full.
<b>AvaSpec-ULS2048 CL-EVO-UA-50</b>	Ultra-low stray light fiber-optic UV/VIS/NIR spectrometer, 2048 pixel CMOS detector, grating UA (200-1100 nm), slit 50, OSC-UA, DCL-UV/VIS-200, USB3 powered, high speed USB3 and ETH interface. Includes AvaSoft-Full.
<b>AvaSpec-ULS2048 CL-EVO-VA-50</b>	Ultra-low stray light fiber-optic VIS/NIR spectrometer, 2048 pixel CMOS detector, grating VA (360-1100 nm), slit 50, OSC, DCL-UV/VIS-200, USB3 powered, high speed USB3 and ETH interface. Includes AvaSoft-Full.
<b>AvaSpec-ULS2048 CL-EVO-RS-BB</b>	Ultra-low stray light fiber-optic VIS spectrometer, 2048 pixel CMOS detector, grating BB (360-880 nm), OSF-305, OSC, USB3 powered, high speed USB3 and ETH interface. Includes AvaSoft-Full and slit kit SMA (slit 25-RS preinstalled; 50, 100 and 200 µm in box).

## SPECTROMETERS IN STOCK

The spectrometers mentioned above are kept in stock and are quickly shipped after receiving your order confirmation. Contact us for more information.

# CompactLine - AvaSpec-NEXOS™ Spectrometer with 2k CMOS Detector

Avantes' NEXOS™ Spectrometer is a small, lightweight, and powerful spectrometer optimized for spectroscopy integration to deliver high-end performance. The device is available with a 2K detector, offering high-speed performance, with integration times of up to 9  $\mu$ s, minimal stray light as low as 0.1%, and a strong signal-to-noise ratio of 375:1.

The new powerful and versatile spectrometer is available with USB2 communication. This device can be customized to your needs using six different slit sizes and more than 15 types of gratings. The replaceable slit option is standard for Non-OEM.

The NEXOS™ Spectrometer is highly suitable for Original Equipment Manufacturer (OEM) applications and can be combined with our Software Development Kits (AvaSoft). Thanks to the automation of our manufacturing process, Avantes can produce high volumes of the NEXOS™ Spectrometer more efficiently and faster with very high accuracy and reproducibility.



## Technical Data

Optical Bench	Symmetrical Czerny-Turner design, 75 mm focal length; spectrometer bench
Wavelength range	190 - 1100 nm
Stray light	0.1 - 1% (typical value 300l/mm, blaze 300 nm < 0.3%)
Detector	HAM S11639, CMOS linear array, 2048 pixels (14x200 $\mu$ m)
Signal/Noise	375:1
Dynamic Range	4500
Dark noise	15 cnts
AD converter	16-bit, 6 MHz
Integration time	9 $\mu$ s – 30 s
Interface	USB 2.0 (480Mbps) / pigtailed (38cm) USB-A
Sample speed on-board averaging	0.36 ms/scan
Data transfer speed	0.79 ms/scan
Digital I/O	5 bidirectional programmable I/O; 1 Analog out, 1 Analog in, 1x5V
Dimensions, weight	105 x 80 x 20 mm, 277,5 grams
Power supply	Default USB power, 500 mA
Temperature range	5-55 °C

## FULL PRODUCT SPECIFICATIONS

Want to know the full product specifications, gratings selection, resolution table, accessories options and ordering information?  
Click **here** or scan the QR code on the right



# CompactLine - AvaSpec-NEXOS™ Spectrometer with 4k CMOS Detector

Avantes' NEXOS™ Spectrometer is a small, lightweight, and powerful spectrometer optimized for spectroscopy integration to deliver high-end performance. The device is available with 4K detector, offering high-speed performance, with integration times of up to 9 μs, minimal stray light as low as 0.1%, and a strong signal-to-noise ratio of 365:1.

The new powerful and versatile spectrometer is available with USB2 communication. This device can be customized to your needs using six different slit sizes and more than 15 types of gratings. The replaceable slit option is standard for Non-OEM.

The NEXOS™ Spectrometer is highly suitable for Original Equipment Manufacturer (OEM) applications and can be combined with our Software Development Kits (AvaSoft). Thanks to the automation of our manufacturing process, Avantes can produce high volumes of the NEXOS™ Spectrometer more efficiently and faster with very high accuracy and reproducibility.



## Technical Data

Optical Bench	Symmetrical Czerny-Turner design, 75 mm focal length; spectrometer bench
Wavelength range	190 - 1100 nm
Stray light	0.1 - 1% (typical value 300l/mm, blaze 300 nm < 0.3%)
Detector	HAM S13496, CMOS linear array, 4096 pixels (7x200μm)
Signal/Noise	365:1
Dynamic Range	4500
Dark noise	15 cnts
AD converter	16-bit, 6 MHz
Integration time	9 μs – 30 s
Interface	USB 2.0 (480Mbps) / pigtailed (38cm) USB-A
Sample speed on-board averaging	0.70 ms/scan
Data transfer speed	1.12 ms/scan
Digital I/O	5 bidirectional programmable I/O; 1 Analog out, 1 Analog in, 1x5V
Dimensions, weight	105 x 80 x 20 mm, 277,5 grams
Power supply	Default USB power, 500 mA
Temperature range	5-55 °C

## FULL PRODUCT SPECIFICATIONS

Want to know the full product specifications, gratings selection, resolution table, accessories options and ordering information? Click [here](#) or scan the QR code on the right



# CompactLine - AvaSpec-NEXOS™ Link Spectrometer with SPI or RS232 Communication Protocol

Avantes' NEXOS™ Spectrometer is a small, lightweight, and powerful spectrometer optimized for spectroscopy integration to deliver high-end performance. The device is available with a 2K or 4K detector, offering high-speed performance, with integration times of up to 9  $\mu$ s, minimal stray light as low as 0.1%, and a strong signal-to-noise ratio of 375:1.

The NEXOS™ Link variation is the ideal choice if you want to integrate the device into a system that requires a different communication protocol. The Link comes with RS232 or SPI communication protocols, which allows you to enhance the functionality of your equipment.

The NEXOS™ Spectrometer is highly suitable for Original Equipment Manufacturer (OEM) applications and can be combined with our Software Development Kits (AvaSoft). Thanks to the automation of our manufacturing process, Avantes can produce high volumes of the NEXOS™ Spectrometer more efficiently and faster with very high accuracy and reproducibility.



## Technical Data

	NEXOS™ 2K	NEXOS™ 4K
Optical Bench	Symmetrical Czerny-Turner design, 75 mm focal length; spectrometer bench	
Wavelength range	190 - 1100 nm	
Stray light	0.1 - 1% (typical value 300l/mm, blaze 300 nm < 0.3%)	
Detector	HAM S11639, CMOS linear array, 2048 pixels (14x200 $\mu$ m)	HAM S13496, CMOS linear array, 4096 pixels (7x200 $\mu$ m)
Signal/Noise	375:1	365:1
Dynamic Range	4500	
Dark noise	15 cnts	
AD converter	16-bit, 6 MHz	
Integration time	9 $\mu$ s – 30 s	
Interface	RS232 or SPI pigtailed with separate power connection	
Digital I/O	5 bidirectional programmable I/O; 1 Analog out, 1 Analog in, 1x5V	
Dimensions, weight	105 x 80 x 20 mm, 277,5 grams	
Power supply	Seperate	
Temperature range	5-55 °C	

## FULL PRODUCT SPECIFICATIONS

Want to know the full product specifications, gratings selection, resolution table, accessories options and ordering information?  
Click **here** or scan the QR code on the right



# CompactLine - AvaSpec-Mini2048CL

## Small & Powerful OEM Spectrometer

The AvaSpec-Mini is an excellent choice for those looking for a small spectrometer with a resolution of up to 0.1 nm. It's compact, about the size of a deck of cards, yet it delivers an impressive dynamic range better than 3000:1, with low stray light levels between 0.2 and 1%, and weighing only 175 grams, making it easy to take anywhere.

The AvaSpec-Mini2048CL is manufactured using our semi-automated production process, AvaMation, which ensures excellent unit-to-unit reproducibility and temperature stability. These are essential parameters for OEM customers requiring reliable product integration. The device suits various research areas, such as light analysis, chemical research, and Raman spectroscopy. The possibilities are endless.

Moreover, the AvaSpec-Mini works seamlessly with AvaSoft software and the Windows and Linux libraries.

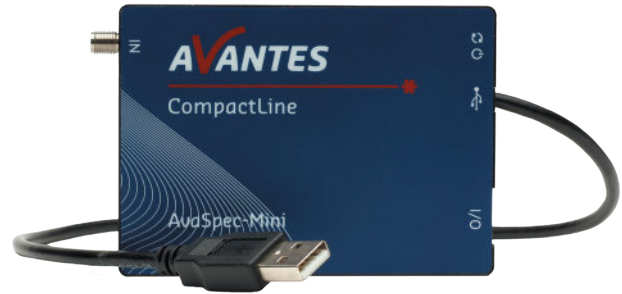

### Technical Data

<b>Optical bench</b>	Symmetrical Czerny-Turner, 75 mm focal length, MK II
<b>Wavelength range</b>	200 - 1100 nm
<b>Stray light</b>	0.2 - 1%
<b>Sensitivity</b>	337.500
<b>Detector</b>	HAM S11639 , CMOS linear array, 2048 pixels (14x200 μm)
<b>Signal/noise</b>	330:1
<b>Dynamic range</b>	3300
<b>Dark noise</b>	16 cnts
<b>AD converter</b>	16-bit, 6 MHz
<b>Integration time</b>	30 μs - 40 s
<b>Interface</b>	USB 2.0 (480 Mbps) / pigtailed (40 cm) USB-A
<b>Sample speed with on-board averaging</b>	3.0 ms/scan
<b>Data transfer speed</b>	4.6 ms/scan
<b>I/O</b>	5 bidirectional programmable I/O; 1 analog out; 1 analog in, 1x5V
<b>Dimensions, weight</b>	95 x 68 x 20 mm, 175 grams
<b>Power supply</b>	Default USB power, 500 mA
<b>Temperature range</b>	0-55°C

### FULL PRODUCT SPECIFICATIONS

Want to know the full product specifications, gratings selection, resolution table, accessories options and ordering information? Click **here** or scan the QR code on the right



# CompactLine - AvaSpec-Mini4096CL

## Small & Powerful OEM spectrometer

The AvaSpec-Mini4096CL is the first miniature spectrometer to hit the market with a 4K pixel CMOS array, offering high resolution (up to 0.09 nm) and a small form factor (only the size of a deck of cards). Despite its small size, it delivers a dynamic range of better than 3000:1, stray light levels between 0.2 and 1%, and weighs only 175 grams, making it easy to carry around.

Produced with our semi-automated production process, AvaMation, the AvaSpec-Mini4096CL provides excellent unit-to-unit reproducibility and temperature stability, which are essential parameters for OEM customers seeking reliable integration into their products. The device covers a wide range of research areas, including light analysis, chemical research, and Raman spectroscopy, making it a versatile tool for scientific exploration.

Moreover, the AvaSpec-Mini4096CL works seamlessly with Avantes spectroscopy software and the Windows and Linux libraries.



### Technical Data

<b>Optical bench</b>	Symmetrical Czerny-Turner, 75 mm focal length, MK II
<b>Wavelength range</b>	200 - 1100 nm
<b>Stray light</b>	0.2 - 1%
<b>Sensitivity</b>	261.000
<b>Detector</b>	HAM S13496 , CMOS linear array, 4096 pixels (7x200µm)
<b>Signal/noise</b>	300:1
<b>Dynamic range</b>	3300
<b>Dark noise</b>	16 cnts
<b>AD converter</b>	16-bit, 6 MHz
<b>Integration time</b>	30 µs - 50 s
<b>Interface</b>	USB 2.0 (480 Mbps) / pigtailed (40 cm) USB-A
<b>Sample speed with on-board averaging</b>	6.5 ms/scan
<b>Data transfer speed</b>	8.9 ms/scan
<b>I/O</b>	5 bidirectional programmable I/O; 1 analog out; 1 analog in, 1x5V
<b>Dimensions, weight</b>	95 x 68 x 20 mm, 175 grams
<b>Power supply</b>	Default USB power, 500 mA
<b>Temperature range</b>	0-55°C

### FULL PRODUCT SPECIFICATIONS

Want to know the full product specifications, gratings selection, resolution table, accessories options and ordering information? Click **here** or scan the QR code on the right



# CompactLine - AvaSpec-Mini-NIR

## Small & Powerful OEM NIR spectrometer

The AvaSpec-Mini-NIR is a compact near-infrared spectrometer based on a combination of our popular AvaSpec-NIR256-1.7 and Mini-series. Like our other CompactLine spectrometers, this device is only the size of a deck of cards. The Mini is USB-powered, making integrating into other devices, including OEM handheld applications, smooth and easy.

The AvaSpec-Mini-NIR is highly robust since it has no moving parts and can be used in virtually any environment. Additionally, it works seamlessly with our AvaSoft software and the available Windows and Linux libraries.

If size is not the most critical factor for your application, we recommend the AvaSpec-NIR256-1.7-EVO, the bigger brother of the Mini-NIR, which offers slightly higher sensitivity levels.



### Technical Data

<b>Optical bench</b>	Symmetrical Czerny-Turner, 75 mm focal length, MK II
<b>Wavelength range</b>	900-1700 nm
<b>Sensitivity HS in counts/μW per ms</b>	665,000 (integral 1000-1750 nm)
<b>Dynamic range HS</b>	4750:1
<b>Integration time HS</b>	10 μs-300 ms
<b>Signal/noise HS</b>	1900:1
<b>Dark noise HS</b>	14 counts
<b>Sensitivity LN in counts/μW per ms</b>	38,000 (integral 1000-1750 nm)
<b>Dynamic range LN</b>	7500:1
<b>Integration time LN</b>	10 μs-5 seconds
<b>Signal/noise LN</b>	5000:1
<b>Dark noise LN</b>	9 counts
<b>Detector</b>	InGaAs array, 256 pixels
<b>AD converter</b>	16-bit, 500 kHz
<b>Interface</b>	USB2.0 (480 Mbps)/pigtailed (40 cm) USB-A
<b>Sample speed with store to RAM</b>	0.53 ms/scan
<b>Data transfer speed</b>	1.2 ms/scan
<b>I/O</b>	5 bidirectional programmable I/O: 1 analog out, 1 analog in, 1 x 5V
<b>Power supply</b>	Default USB power, 500 mA
<b>Dimensions, weight</b>	95 x 68 x 20 mm, 185 g
<b>Temperature range</b>	0-55°C

### FULL PRODUCT SPECIFICATIONS

Want to know the full product specifications, gratings selection, resolution table, accessories options and ordering information? Click [here](#) or scan the QR code on the right



# StarLine - AvaSpec-VARIUS™ Spectrometer with 2k CMOS Detector

Meet the VARIUS™, a flexible spectrometer specifically designed to meet the needs of a wide variety of applications. The VARIUS™ is available with a 2k pixel detector, and compatible with Avantes light sources, accessories, and AvaSoft software.

Crafted with patent-pending technology, the Varius™ redefines versatility, delivering precision like never before. Adapt seamlessly to every challenge by replacing the slit with the new cover. Achieve 0.1-1% stray light, superior signal-to-noise ratios, and seamless USB 3.0/Ethernet connectivity. Its plug-and-play solution allows for easy and immediate deployment.

Additionally, the VARIUS™ spectrometer provides excellent price-to-performance ratio, making it a great choice for laboratories and research institutions seeking a powerful, reliable, and affordable spectroscopy solution.



## Technical Data

Optical Bench	Symmetrical Czerny-Turner design, 75 mm focal length; VRS bench
Wavelength range	190 - 1100 nm
Stray light	0.1 - 1% (typical value 300 l/mm, blaze 300 nm < 0.3%)
Detector	HAM S11639, CMOS linear array, 2048 pixels (14x200 µm)
Signal/Noise	375:1
Dynamic Range	4500
Dark noise	15 cnts
AD converter	16-bit, 6 MHz
Integration time	9 µs – 30 s
Interface	USB 3.0 high speed (5Gbps), Gigabit Ethernet (1 Gbps)
Sample speed on-board averaging	0.38 ms/scan
Data transfer speed	0.38 ms/scan (USB3.0), 1.0 ms (ETH)
Digital I/O	HD-26 connector, 2 Analog in, 2 Analog out, 13 Digital bidirectional, trigger, sync., strobe, laser
Dimensions, weight	183 x 130 x 45,2 mm, 1068 grams
Power supply	Default USB3 power, 500 mA or 12 VDC, 300 mA
Temperature range	5-55 °C

## FULL PRODUCT SPECIFICATIONS

Want to know the full product specifications, gratings selection, resolution table, accessories options and ordering information?  
Click **here** or scan the QR code on the right





# StarLine - AvaSpec-VARIUS™ Spectrometer with 4k CMOS Detector

Meet the VARIUS™, a flexible spectrometer specifically designed to meet the needs of a wide variety of applications. The VARIUS™ is available with a 4k pixel detector, and compatible with Avantes light sources, accessories, and AvaSoft software.

Crafted with patent-pending technology, the Varius™ redefines versatility, delivering precision like never before. Adapt seamlessly to every challenge by replacing the slit with the new cover. Achieve 0.1-1% stray light, superior signal-to-noise ratios, and seamless USB 3.0/Ethernet connectivity. Its plug-and-play solution allows for easy and immediate deployment.

Additionally, the VARIUS™ spectrometer provides excellent price-to-performance ratio, making it a great choice for laboratories and research institutions seeking a powerful, reliable, and affordable spectroscopy solution.



### Technical Data

Optical Bench	Symmetrical Czerny-Turner design, 75 mm focal length; VRS bench
Wavelength range	190 - 1100 nm
Stray light	0.1 - 1% (typical value 300 l/mm, blaze 300 nm < 0.3%)
Detector	HAM S13496, CMOS linear array, 4096 pixels (7x200 μm)
Signal/Noise	365:1
Dynamic Range	4500
Dark noise	15 cnts
AD converter	16-bit, 6 MHz
Integration time	9 μs – 30 s
Interface	USB 3.0 high speed (5Gbps), Gigabit Ethernet (1 Gbps)
Sample speed on-board averaging	0.70 ms/scan
Data transfer speed	0.70 ms/scan (USB3.0), 1.31 ms (ETH)
Digital I/O	HD-26 connector, 2 Analog in, 2 Analog out, 13 Digital bidirectional, trigger, sync., strobe, laser
Dimensions, weight	183 x 130 x 45,2 mm, 1068 grams
Power supply	Default USB3 power, 500 mA or 12 VDC, 300 mA
Temperature range	5-55 °C

### FULL PRODUCT SPECIFICATIONS

Want to know the full product specifications, gratings selection, resolution table, accessories options and ordering information? Click **here** or scan the QR code on the right



# StarLine - AvaSpec-VARIUS™ OEM Spectrometer for Original Equipment Manufacturing customers

Meet the VARIUS™ OEM, a flexible spectrometer specifically designed for integrating into your product or system. The VARIUS™ OEM is available with a 2k or 4k pixel detector, both of which are compatible with Avantes light sources, accessories, and AvaSoft software.

Its robust industrial stainless steel electromagnetic compatible housing contains brackets on the side for easy integration. The VARIUS™ OEM meets the latest EMC requirements for medical devices. Experience high-speed data transfer, stray light as low as 0,1%, and superior signal-to-noise ratios.

The VARIUS™ OEM is engineered to withstand harsh conditions, provide reliable and accurate measurements, and enable efficient data integration with other machinery or control systems. Its versatility and adaptability make it well-suited for in-line quality control, process monitoring, and automation applications.



## Technical Data

	AvaSpec-VARIUS™ 2K	AvaSpec-VARIUS™ 4K
Optical Bench	Symmetrical Czerny-Turner design, 75 mm focal length; VRS bench	
Wavelength range	190 - 1100 nm	
Stray light	0.1 - 1% (typical value 300 l/mm, blaze 300 nm < 0.3%)	
Detector	HAM S11639, CMOS linear array, 2048 pixels (14x200 μm)	HAM S13496, CMOS linear array, 4096 pixels (7x200 μm)
Signal/Noise	375:1	365:1
Dynamic Range	4500	
Dark noise	15 cnts	
AD converter	16-bit, 6 MHz	
Integration time	9 μs – 30 s	
Interface	USB 3.0 high speed (5Gbps), Gigabit Ethernet (1 Gbps)	
Sample speed on-board averaging	0.38 ms/scan	0.70 ms/scan
Data transfer speed	0.38 ms/scan (USB3.0), 1.0 ms (ETH)	0.70 ms/scan (USB3.0), 1.31 ms (ETH)
Digital I/O	HD-26 connector, 2 Analog in, 2 Analog out, 13 Digital bidirectional, trigger, sync., strobe, laser	
Dimensions, weight	179 x 110,1 x 44,8 mm, 799,5 grams	
Power supply	Default USB3 power, 500 mA or 12 VDC, 300 mA	
Temperature range	5-55 °C	

## FULL PRODUCT SPECIFICATIONS

Want to know the full product specifications, gratings selection, resolution table, accessories options and ordering information?  
Click [here](#) or scan the QR code on the right



# StarLine EVO Series - AvaSpec-ULS2048CL-EVO with 2k CMOS Detector

The AvaSpec-ULS2048CL-EVO spectrometer utilizes the latest CMOS technology instead of conventional CCD technology. With the latest AS-7010 electronics, this versatile device offers USB3.0 communication with ten times higher speed compared to USB2, as well as a second communication port with Gigabit Ethernet for integration into your company network and long-distance communication.

In addition to the high-speed communication options, the EVO has a fast microprocessor and 50 times more memory, allowing you to store more spectra onboard and realize more functionality. This product is available as an OEM unit, bench only, or rack-mount version.

Options include a detector collection lens to enhance sensitivity in the 200-1100 nm range and an order-sorting filter to reduce 2nd order effects. The AvaSpec-2048CL is also available with a wide range of slit sizes, gratings, and fiber-optic entrance connectors. It comes complete with AvaSoft-Basic software, a USB cable, and an extensive manual.



SPECTROMETERS

## Technical Data

<b>Optical Bench</b>	ULS Symmetrical Czerny-Turner, 75 mm focal length
<b>Wavelength range</b>	200-1100 nm
<b>Resolution</b>	0.06 –20 nm, depending on configuration (see table)
<b>Stray light</b>	0.19-1.0%, depending on the grating
<b>Sensitivity</b>	375,000 counts/μW per ms integration time
<b>Detector</b>	CMOS linear Image Sensor
<b>Signal/Noise</b>	300:1
<b>AD converter</b>	16-bit, 6 MHz
<b>Integration time</b>	9 μs – 59s
<b>Interface</b>	USB 3.0 high-speed, 5 Gbps, Gigabit Ethernet 1 Gbps
<b>Sample speed with on-board averaging</b>	0.38 ms /scan
<b>Dynamic Range</b>	4000
<b>Data transfer speed</b>	0.38 ms/scan (USB3), 1.0 ms (ETH)
<b>Digital IO</b>	HD-26 connector, 2 Analog in, 2 Analog out, 13 Digital bidirectional, trigger, sync., strobe, laser
<b>Power supply</b>	Default USB3 power, 500 mAOr 12VDC, 300 mA
<b>Dimensions, weight</b>	177 x 127 x 44,5 mm (1 channel), 1135 grams

## FULL PRODUCT SPECIFICATIONS

Want to know the full product specifications, gratings selection, resolution table, accessories options and ordering information?  
Click [here](#) or scan the QR code on the right



# StarLine EVO Series - AvaSpec-ULS4096CL-EVO with 4k CMOS Detector

The AvaSpec-ULS4096CL-EVO is a spectrometer that utilizes the latest technology by using CMOS technology instead of conventional CCD technology. This technology ensures a spectrometer platform for the coming years. The dominance of CCD detectors in the spectrometer field is fading, and new technologies like CMOS have evolved and become a suitable alternative.

The spectrometer comes equipped with the latest AS-7010 electronics that offer a versatile device. It includes USB 3.0 communication with 10x higher speed than USB2 and a second communication port that offers Gigabit Ethernet for integration into your company network, providing possibilities for long-distance communication. The EVO also includes a fast microprocessor and 50x more memory to store more spectra onboard and realize more functionality.

This product is available with a wide range of slit sizes, gratings, and fiber-optic entrance connectors. It also includes options such as a detector collection lens to enhance sensitivity in the 200-1100 nm range and an order-sorting filter to reduce 2nd order effects. It comes with AvaSoft-Basic software, a USB cable, and an extensive manual.

The AvaSpec-ULS4096CL-EVO is available as an OEM unit, Bench only, or Rackmount version. With 4096 pixels, this spectrometer is tailored for high-resolution applications like Plasma and LIBS.



## Technical Data

<b>Optical Bench</b>	ULS Symmetrical Czerny-Turner, 75 mm focal length
<b>Wavelength range</b>	200-1100 nm
<b>Resolution</b>	0.05 –20 nm, depending on configuration (see table)
<b>Stray light</b>	0.19-1.0%, depending on the grating
<b>Sensitivity</b>	218.000 counts/ $\mu$ W per ms integration time
<b>Detector</b>	CMOS linear Image Sensor
<b>Signal/Noise</b>	335:1
<b>AD converter</b>	16-bit, 6 MHz
<b>Integration time</b>	9 $\mu$ s – 40s
<b>Interface</b>	USB 3.0 high-speed, 5 Gbps, Gigabit Ethernet 1 Gbps
<b>Sample speed with on-board averaging</b>	0.70 ms /scan
<b>Dynamic Range</b>	3600
<b>Data transfer speed</b>	0.70 ms/scan (USB3), 1.31 ms (ETH)
<b>Digital IO</b>	HD-26 connector, 2 Analog in, 2 Analog out, 13 Digital bidirectional, trigger, sync., strobe, laser
<b>Power supply</b>	Default USB3 power, 532 mA Or 12VDC, 300 mA
<b>Dimensions, weight</b>	177 x 127 x 44,5 mm (1 channel), 1155 grams

## FULL PRODUCT SPECIFICATIONS

Want to know the full product specifications, gratings selection, resolution table, accessories options and ordering information?  
Click [here](#) or scan the QR code on the right



## StarLine - AvaSpec-RS spectrometer with Replaceable Slit

For most customers, the choice between throughput and resolution is a challenging one to make. Avantes now allows end-users to quickly replace a slit by introducing our replaceable-slit feature. The replaceable slit option is available on Ultra-low Stray light (ULS) AvaSpecs. On our AvaSpec-HERO & NIR spectrometers, this is standard. The slit sets contain 25, 50, 100, and 200  $\mu\text{m}$  slits along with a screwdriver tool to facilitate the change.

Slit kits are available with SMA-905 connectors, as well as FC/PC connectors. Slit sets can be ordered separately for the -RS spectrometer. For more information about our slit kits, see the accessories section of this catalog.

No recalibration of the spectrometer is needed when changing the slit because of the high-precision slit positioning.



### Technical Data

<b>Slit set connectors</b>	SMA-905 or FC/PC
<b>Slit sizes</b>	25, 50, 100, 200 or 500 $\mu\text{m}$ (width) x 1 mm (height)
<b>Material</b>	Stainless steel
<b>Fixing screws</b>	Torx (included)

### FULL PRODUCT SPECIFICATIONS

Want to know the full product specifications, gratings selection, resolution table, accessories options and ordering information?

Click [here](#) or scan the QR code on the right



# SensLine - AvaSpec-ULS2048XL-EVO

## High UV and NIR Sensitivity Back-Thinned CCD spectrometer

The AvaSpec-ULS2048XL-EVO spectrometer combines exceptional quantum efficiency with high speed, making it a valuable tool. Unlike many back-thinned CCD spectrometers that have two-dimensional arrays, this instrument has large monolithic pixels measuring 14x500 microns, which deliver exceptional efficiency in the UV range (200-400 nm) and the NIR range (950-1160 nm). Additionally, the instrument features an electronic shutter that enables integration times as low as 2 microseconds. A detector collection lens is available to further enhance sensitivity, which improves sensitivity up to 60% when combined with larger core fibers.

The AvaSpec-ULS2048XL-EVO is configurable with a wide range of slit sizes, gratings, and fiber-optic entrance connectors (SMA or FC/PC). It also offers options such as an order-sorting filter to reduce 2nd order effects and purge ports for deep-UV measurements.

The AvaSpec-ULS2048XL-EVO uses the AS7010 electronics board, offering USB3 and Gigabit Ethernet connectivity with better signal processing. The instrument delivers a scan every two milliseconds, and it comes complete with AvaSoft-basic software, a USB cable, and an extensive manual.



### Technical Data

<b>Optical Bench</b>	ULS, Symmetrical Czerny-Turner, 75 mm focal length
<b>Wavelength range</b>	200 - 1160 nm
<b>Resolution</b>	0.09 – 20 nm, depending on configuration (see table)
<b>Stray light</b>	< 0.5%
<b>Sensitivity</b>	460,000 counts/μW per ms int. time
<b>Detector</b>	Back-thinned CCD image sensor 2048 pixels
<b>Signal/Noise</b>	525:1
<b>AD converter</b>	16-bit, 1 MHz
<b>Integration time</b>	2 μs – 20 seconds
<b>Interface</b>	USB 3.0 high-speed, 5 Gbps Gigabit Ethernet 1 Gbps
<b>Sample speed with store to RAM</b>	2.44 ms /scan
<b>Dark Noise</b>	4.5 cnt RMS
<b>Dynamic Range</b>	13.700
<b>Data transfer speed</b>	2.44 ms /scan (USB3)
<b>Digital IO</b>	HD-26 connector, 2 Analog in, 2 Analog out, 3 Digital in, 12 Digital out, trigger, synchronization
<b>Power supply</b>	Default USB power, 700 mA. Or external 12VDC, 360 mA
<b>Dimensions, weight</b>	175 x 127 x 44,5 mm (1 channel), 1180 grams

### FULL PRODUCT SPECIFICATIONS

Want to know the full product specifications, gratings selection, resolution table, accessories options and ordering information?  
Click [here](#) or scan the QR code on the right



# SensLine - AvaSpec-HERO SensLine

## High resolution & sensitivity spectrometer

The AvaSpec-HERO spectrometer is designed with a High Sensitivity Compact (HSC) optical bench (f=100mm; NA=0.13) and a 1024x58 back-thinned CCD detector, providing high sensitivity and resolution.

This instrument is equipped with thermoelectric cooling, allowing long integration times in low-light conditions. The AS7010 electronics, including a high-end AD converter, minimizing noise, resulting in excellent Signal to Noise and Dynamic Range performance.

A range of gratings and slits are available, providing flexibility for various applications in the 200-1160 nm wavelength range. From low light fluorescence to demanding Raman applications, the AvaSpec-HERO is a perfect choice.

With the high-speed USB 3.0 and Gigabit Ethernet communication interface, connecting the instrument to your computer is fast and straightforward. Additionally, the digital IO ports allow for external triggering, control of shutters, and pulsed light sources from the Avantes instrument line.

The AvaSpec-HERO comes standard with replaceable slits, offering optimal flexibility for various applications. Overall, the combination of features makes the AvaSpec-HERO the perfect choice for all your spectroscopic measurements.



### Technical Data

<b>Optical Bench</b>	HSC Symmetrical Czerny-Turner, 100 mm focal length, NA: 0.13
<b>Wavelength range</b>	200-1160 nm
<b>Resolution</b>	0.2-7 nm, depending on configuration (see table)
<b>Stray light</b>	0.5%, depending on the grating
<b>Sensitivity</b>	445,000 counts/ $\mu$ W per ms integration time
<b>Detector</b>	CCD array image sensor with one stage TE Cooled, 1024 pixels
<b>Cooling</b>	Max. $\Delta T = 30$ °C versus ambient
<b>Signal/Noise</b>	1200:1
<b>Dynamic Range</b>	40.000
<b>AD converter</b>	16-bit, 250 kHz
<b>Integration time</b>	5.2 ms– 60 sec
<b>Interface</b>	USB 3.0 high-speed, 5 Gbps, Gigabit Ethernet 1 Gbps
<b>Digital IO</b>	HD-26 connector, 2 Analog in, 2 Analog out, 3 Digital bidirectional, trigger, sync., strobe, laser.
<b>Sample speed with on-board averaging</b>	5.2 ms/scan
<b>Data transfer speed</b>	5.2 ms/scan (USB3 and ETH)
<b>Power supply</b>	12VDC, 1.5A
<b>Dimensions, weight</b>	185 x 161 x 185mm, 3500 grams

### FULL PRODUCT SPECIFICATIONS

Want to know the full product specifications, gratings selection, resolution table, accessories options and ordering information? Click **here** or scan the QR code on the right



# SensLine - AvaSpec-ULS2048x64TEC-EVO

## Thermoelectrically Cooled Fiber-Optic Spectrometer

This instrument enhances the Sensline series with its cooled, back-thinned detector. The back-thinned detector has good sensitivity in the UV and IR regions. The 64-pixel height (0.89 mm) enables catching as many photons as possible, while the cooling allows long integration times of up to 120 seconds with low noise levels.

The instrument features a Peltier cooling device integrated into our exclusive ultra-low stray light optical bench, which can reduce the temperature of the CCD chip to  $-30^{\circ}\text{C}$  against ambient, improving the dark baseline and PRNU level significantly. The detector cooling also reduces the dark noise by a factor of 2-3.

The AvaSpec-ULS2048x64TEC-EVO uses a special low-noise version of the 2048x64 detector with integrated cooling. All the above features make this instrument ideal for measuring low-light applications, such as fluorescence or low-light Raman measurements. Optimal flexibility is guaranteed with the replaceable slit, making the instrument suitable for various kinds of applications.



### Technical Data

<b>Optical bench</b>	ULS Symmetrical Czerny-Turner, 75 mm focal length
<b>Wavelength range</b>	200-1160 nm
<b>Resolution</b>	0.09 –20 nm, depending on configuration (see table)
<b>Stray light</b>	<1%, depending on the grating
<b>Sensitivity</b>	300,000 counts/ $\mu\text{W}$ per ms integration time
<b>Detector</b>	Backthinned CCD, 2048x64 pixels, low noise, integrated cooling
<b>Temperature-cooled CCD</b>	Max. $\Delta\text{T} = 30^{\circ}\text{C}$ versus ambient Optimal setting: $5^{\circ}\text{C}$
<b>Signal/noise</b>	550:1
<b>AD converter</b>	16-bit, 500 KHz
<b>Dynamic range</b>	19,000
<b>Dark noise</b>	5 cnts
<b>Integration time</b>	9.7 ms–120 s
<b>Interface</b>	USB 3.0 high speed, 5 Gbps, Gigabit Ethernet 1 Gbps
<b>Sample speed with on-board averaging</b>	9.7 ms/scan
<b>Data transfer speed</b>	9.7 ms/scan (USB3), 9.7 ms/scan (ETH)
<b>Digital IO</b>	HD-26 connector, 2 Analog in, 2 Analog out, 13 Digital bidirectional, trigger, sync., strobe, laser
<b>Power supply</b>	12 VDC, 1.5 A
<b>Operating temperature</b>	$0-40^{\circ}\text{C}$
<b>Cooling</b>	Max. $\Delta\text{T} = 30^{\circ}\text{C}$ versus ambient
<b>Dimensions, weight</b>	185 x 145 x 185 mm, 3500 grams

### FULL PRODUCT SPECIFICATIONS

Want to know the full product specifications, gratings selection, resolution table, accessories options and ordering information?  
Click [here](#) or scan the QR code on the right





# SensLine - AvaSpec-HS2048XL-EVO

## High UV and NIR Sensitivity Back-Thinned CCD Spectrometer

The AvaSpec-HS2048XL-EVO is an exceptional instrument for high sensitivity applications where high resolution is not of paramount concern. It features Avantes' HS optical bench, which has a full 0.22 numerical aperture for superior throughput. The back-thinned CCD detector has 2048 large monolithic pixels measuring 14x500 microns, with high efficiency in the UV (200-400 nm) and NIR (950-1160 nm) while retaining sensitivity in the visible range. The unique optical design includes toroid collimating and focusing mirrors to control image magnification and enhance efficiency.

The instrument also has an electronic shutter, allowing integration times as low as 2 microseconds.

For configurations requiring second-order filtering, order-sorting filters are available. The AvaSpec-HS2048XL is also available with a wide range of slit sizes and gratings and may be configured with SMA or FC/PC fiber-optic entrance connectors. The AvaSpec-HS2048XL-EVO uses the AS7010 electronics board, which offers USB3, Gigabit Ethernet, and better signal processing. This instrument is ideally suited for diffuse reflection (UV, VIS, NIR) and fluorescence measurements.



### Technical Data

<b>Optical Bench</b>	High-sensitivity asymmetrical design, 37.5 mm focal length; NA – 0.22, f/2.27
<b>Wavelength range</b>	200 - 1160 nm
<b>Resolution</b>	1 - 20 nm, depending on configuration (see table)
<b>Stray light</b>	< 1 %
<b>Sensitivity</b>	1,250,000 counts/μW per ms int. time
<b>UV Quantum efficiency</b>	60% (200-300 nm)
<b>Detector</b>	Back-thinned CCD image sensor 2048 pixels
<b>Signal/Noise</b>	525:1
<b>AD converter</b>	16-bit, 1 MHz
<b>Integration time</b>	2 μs – 600 seconds
<b>Interface</b>	USB 3.0 high-speed, 5 Gbps Gigabit Ethernet, 1 Gbps
<b>Sample speed with on-board averaging</b>	2.44 ms /scan
<b>Dynamic Range</b>	14.900
<b>Data transfer speed</b>	2.44 ms /scan (USB3)
<b>Digital IO</b>	HD-26 connector, 2 Analog in, 2 Analog out, 3 Digital in, 12 Digital out, trigger, synchronization
<b>Power supply</b>	Default USB power, 700 mA. or external 12VDC, 360 mA
<b>Dimensions, weight</b>	175 x 165 x 85 mm, 1,950 kg

### FULL PRODUCT SPECIFICATIONS

Want to know the full product specifications, gratings selection, resolution table, accessories options and ordering information? Click [here](#) or scan the QR code on the right



# SensLine - AvaSpec-ULS2048x64-EVO

## High UV and NIR Sensitivity Spectrometer

Alongside the cooled AvaSpec-ULS2048x64TEC-EVO with low-noise detector, Avantes also offers the more cost-effective, uncooled AvaSpec-ULS2048x64-EVO. With its standard 2048x64 back-thinned detector, this spectrometer is perfect for applications in the UV and NIR range.

For applications that require integration times lower than 2 seconds, the cooling option is often not needed. For example, this uncooled AvaSpec-ULS2048x64-EVO has an established track record in various DOAS applications all over the world because of its high UV response and 0.9 mm detector height that enables detecting the wavelengths of interest.

Options include an order-sorting filter to reduce second-order effects and purge ports for deep-UV measurements. The AvaSpec-ULS2048x64-EVO comes with a wide range of slit sizes and gratings and can be configured with SMA or FC/PC fiber-optic entrance connectors. The AvaSpec-ULS2048x64-EVO uses the AS7010 electronics board offering USB3, Gigabit Ethernet, and better signal processing. The instrument comes complete with AvaSoft-basic software, a USB cable, and an extensive manual.



### Technical Data

<b>Optical bench</b>	ULS, Symmetrical Czerny-Turner, 75 mm focal length
<b>Wavelength range</b>	200-1160 nm
<b>Resolution</b>	0.09–20 nm, depending on configuration (see table)
<b>Stray light</b>	< 1%, depending on the grating
<b>Sensitivity</b>	650,000 counts/μW per ms int. time
<b>Detector</b>	Back-thinned CCD image sensor 2048x64 pixels (height: 0.89 mm)
<b>Signal/noise</b>	450:1
<b>AD converter</b>	16-bit, 1.33 MHz
<b>Integration time</b>	2.4 ms–25 seconds
<b>Interface</b>	USB 3.0 high-speed, 5 Gbps, Gigabit Ethernet 1 Gbps
<b>Sample speed with on-board averaging</b>	2.4 ms/scan
<b>Dark noise</b>	11.5 cnt RMS
<b>Dynamic range</b>	6100
<b>Data transfer speed</b>	2.4 ms/scan (USB3)
<b>Digital IO</b>	HD-26 connector, 2 Analog in, 2 Analog out, 13 Digital bidirectional, trigger, sync., strobe, laser
<b>Power supply</b>	Default USB power, 885 mA. Or external 12VDC, 420 mA
<b>Dimensions, weight</b>	177 x 127 x 44,5 mm (1 channel), 1180 grams

### FULL PRODUCT SPECIFICATIONS

Want to know the full product specifications, gratings selection, resolution table, accessories options and ordering information?  
Click [here](#) or scan the QR code on the right



# NIRLine - AvaSpec-NIR256/512-1.7-EVO

## Near-Infrared Fiber-Optic Spectrometer

Avantes offers a series of uncooled spectrometer configurations suitable for measurements in the near-infrared range up to 1.7  $\mu\text{m}$ . The AvaSpec-NIR256-1.7-EVO and the AvaSpec-NIR512-1.7-EVO use the same high-sensitivity optical bench with the next generation of electronics, delivering exceptional performance specifications. Both instruments offer a sample speed of only 0.53 ms/scan and integration times as fast as 20  $\mu\text{s}$ . If resolution is crucial or more data points are required for modeling, the 512-pixel detector is a better choice for your application.

The AvaSpec-NIR256/512-1.7-EVO spectrometers feature trusted InGaAs array detectors with ultra-low noise electronics boards with a USB3 and Giga-Ethernet connection port. They also have digital and analog I/O ports for external triggering and control over the shutter and pulsed light sources. The instruments come with two distinct software-controlled gain-setting modes, high-sensitivity mode (HS, default) and low-noise (LN) mode.

These affordable, uncooled instruments are USB-powered and available with four gratings and replaceable slits to match the bandwidth and requirements of your application.



### Technical Data

Spectrometer	AvaSpec-NIR256-1.7-EVO	AvaSpec-NIR512-1.7-EVO
Optical Bench	Symmetrical Czerny-Turner, 50 mm focal length,	
Wavelength range	900-1700 nm	
Resolution (slit & grating dependent)	2-50 nm	
Sensitivity HS in counts / $\mu\text{W}$ per ms	8,200,000 (integral 1000-1750 nm)	3,880,000 (integral 1000-1750 nm)
Dynamic Range HS	6000:1	
Integration time HS	10 $\mu\text{s}$ –500 ms	
Signal/Noise HS	1900:1	
Sensitivity LN in counts / $\mu\text{W}$ per ms	469,000 (integral 1000-1750 nm)	222,000 (integral 1000-1750 nm)
Dynamic Range LN	9000:1	
Integration time LN	10 $\mu\text{s}$ –10 s	
Signal/Noise LN	5000:1	
Detector	InGaAs linear array, 256 pixels, 50 $\mu\text{m}$ x 500 $\mu\text{m}$	InGaAs linear array, 512 pixels, 25 $\mu\text{m}$ x 500 $\mu\text{m}$
AD converter	16-bit, 500 kHz	16-bit, 500 kHz
Interface	USB3.0 high speed, 5 Gbps, Gigabit Ethernet 1 Gbps	
Sample speed with store to RAM	0.53 ms/scan	
Data transfer speed	0.53 ms/scan (USB3)	
Digital IO	HD-26 connector, 2 Analog in, 2 Analog out, 13 Digital IO bi-directional, trigger, synchronization, strobe, laser	
Power supply	Default USB power, 600 mA or external 12VDC, 320mA (4W)	
Dimensions, weight	185 x 100 x 184 mm, 2.7 kg	

### FULL PRODUCT SPECIFICATIONS

Want to know the full product specifications, gratings selection, resolution table, accessories options and ordering information? Click **here** or scan the QR code on the right



# NIRLine - AvaSpec-NIR256/512-1.7-HSC-EVO

## Cooled Near-Infrared Fiber-Optic Spectrometer

We offer a range of cooled spectrometer configurations for measurements in the near-infrared range up to 1.7  $\mu\text{m}$ . The AvaSpec-NIR256-1.7-HSC-EVO and the AvaSpec-NIR512-1.7-HSC-EVO feature the high-sensitivity 100mm optical bench (HSC) with the next generation of electronics.

Both instruments provide exceptional performance specifications, including high sample speed and integration times (20  $\mu\text{s}$ ). If resolution is a crucial factor or more data points are required for modeling, the 512-pixel detector is the optimal choice.

The AvaSpec-NIR256/512-1.7-HSC-EVO spectrometers utilize identical trusted InGaAs array detectors with our ultra low-noise electronics board with USB3 and Giga-Ethernet connection ports. Besides their replaceable slit, this device features digital and analog I/O ports that enable external triggering and control over the shutter and pulsed light sources. You can choose two software-controlled gain-setting modes: high-sensitivity (HS, default) and low-noise (LN).

Cooling ensures optimal noise conditions even at longer integration times. All NIR-1.7 instruments come with a choice of four different gratings, making it possible to choose the bandwidth that fits your application.



### Technical Data

Spectrometer	AvaSpec-NIR256-1.7-HSC-EVO	AvaSpec-NIR512-1.7-HSC-EVO
Optical Bench	Symmetrical Czerny-Turner, 100 mm focal length, 1 stage TE-cooled	
Wavelength range	900-1700 nm	
Resolution (slit & grating dependent)	1.9-32 nm	1.7-32 nm
Sensitivity HS in counts / $\mu\text{W}$ per ms	4.800.000 (integral 1000-1750 nm)	2.500.000 (integral 1000-1750 nm)
Dynamic Range HS	4900:1	
Signal/Noise HS	1900:1	
Integration time HS	20 $\mu\text{s}$ -500ms	
Sensitivity LN in counts / $\mu\text{W}$ per ms	160.000 (integral 1000-1750 nm)	83.000 (integral 1000-1750 nm)
Dynamic Range LN	7600:1	
Signal/Noise LN	5000:1	
Integration time LN	20 $\mu\text{s}$ -20 s	
TE-cooled InGaAs linear array Detector	256 pixels, 50 $\mu\text{m}$ x 500 $\mu\text{m}$	512 pixels, 25 $\mu\text{m}$ x 500 $\mu\text{m}$
AD converter	16-bit, 1,2 MHz	16-bit, 1,2 MHz
Interface	USB3.0 high speed, 5 Gbps, Gigabit Ethernet 1 Gbps	
Sample speed with store to RAM	0.13 ms/scan	0.24 ms/scan
Data transfer speed	0.4 ms/scan (USB3)	0.53 ms/scan (USB3)
Digital IO	HD-26 connector, 2 Analog in & out, 13 Digital IO bi-directional, trigger, synchronization, strobe, laser	
Power supply	12VDC, 12W	
Operating temperature	0-40°C	
Cooling	Max. $\Delta\text{T}$ = 25°C versus ambient	
Dimensions, weight	185 x 160 x 184 mm, 3.6 kg	

### FULL PRODUCT SPECIFICATIONS

Want to know the full product specifications, gratings selection, resolution table, accessories options and ordering information?  
Click [here](#) or scan the QR code on the right



# NIRLine - AvaSpec-NIR256/512-2.5-HSC-EVO

## Near-infrared Fiber-Optic Spectrometer

The NIR spectrometers are highly sensitive, compact, and lightweight, with a 100mm optical bench featuring an NA of 0.13, providing a perfect balance between sensitivity and resolution. The 2.5-HSC series includes 256/512 pixel InGaAs detectors available in various configurations for multiple applications, including grain, corn, wheat, soya, polymers, medical use, and process monitoring.

The 256-pixel detectors offer excellent sensitivity for most applications, while the 512-pixel detectors are suitable for high-resolution applications. The -HSC version allows for user-selectable gain settings in either low-noise (LN) or high-sensitivity (HS) mode. The analog and digital IO ports enable external triggering and control of shuttered and pulsed light sources. The EVO instruments use the AS7010 electronics board, which provides faster data transfer with USB3 and Gigabit Ethernet and better signal processing.



### Technical Data

Spectrometer platform	AvaSpec-NIR256-2.5-HSC-EVO	AvaSpec-NIR512-2.5-HSC-EVO
<b>Optical Bench</b>	TE-cooled Symmetrical Czerny Turner, 100 mm focal length	
<b>Wavelength Range</b>	1000-2500 nm	
<b>Resolution (slit &amp; grating dependent)</b>	4.4-85.0 nm	2.6-85.0 nm
<b>Pixel Dispersion (with NIR 075-1.7 grating)</b>	6.2 nm	3.1 nm
<b>Sensitivity HS in counts/μW per ms (1000-2500 nm)</b>	990,000	480,000
<b>Signal/Noise HS</b>	1800:1	1900:1
<b>Integration time HS</b>	10 μs-5 ms	
<b>Sensitivity LN in counts/uW per ms (1000-2500nm)</b>	55,000	26,600
<b>Signal/Noise LN</b>	4000:1	3700:1
<b>Integration time LN</b>	10 μs-100 ms	
<b>Detector</b>	inGaAs linear array with 2-stage TE-cooling, 256 pixel	inGaAs linear array with 2-stage TE-cooling, 512 pixel
<b>Pixel size (WxH)</b>	50 x 250 μm	25 x 250 μm
<b>AD converter</b>	16 bit, 500kHz	
<b>Interface</b>	USB 3.0 high-speed, 5 Gbps - Gigabit Ethernet 1 Gbps	
<b>Sample speed with on-board averaging</b>	0.54 ms/scan (USB3)	
<b>Data transfer speed</b>	1.11 ms/scan (USB3)	
<b>Digital IO</b>	HD-26 connector, 2 Analog in, 2 Analog out, 13 Digital bi-directional, trigger, sync, strobe, laser	
<b>Power supply</b>	12 V, 40W	
<b>Operating Temperature range</b>	0-40°C	
<b>Cooling</b>	Max. ΔT = 45°C versus ambient	
<b>Dimensions, weight</b>	185 x 145 x 185 mm, 3.5 kg	

### FULL PRODUCT SPECIFICATIONS

Want to know the full product specifications, gratings selection, resolution table, accessories options and ordering information? Click [here](#) or scan the QR code on the right



# StarLine - AvaSpec Multi-Channel Spectrometer

With the AvaSpec multi-channel, you can measure more precisely over a broad range or do multiple measurements simultaneously for process control, LIBS, and plasma measurements. You can select from our range of spectrometer detectors and choose different slits or gratings: anything is possible.

Two enclosure options are available: the 9" desktop housing for up to 4 channels and the 19" rack-mountable, which holds a maximum of 10 spectrometers.

For the EVO series, a USB3 and an Ethernet version is available. The Ethernet version (ETH) supports standard seven channels. With the additional hub installed, it can handle up to 10 channels.

Synchronize all channels easily with internal sync cables.

### Benefits:

- Combine up to 10 channels in one enclosure
- Any channel fully configurable to your needs
- Variation in integration times is possible for each channel
- Variation in averaging settings is possible for each channel
- Ideal for process control, LIBS, and plasma measurements



### Technical Data

	Desktop	Rack-mount
<b>Housing</b>	Desktop	Rack-mount
<b>Max nr. Channels</b>	4	10 (UV/VIS)
<b>Dimensions</b>	315 x 235 x 135 mm (d x w x h)	315 x 445 x 135 mm

## FULL PRODUCT SPECIFICATIONS

Want to know the full product specifications, gratings selection, resolution table, accessories options and ordering information?  
Click [here](#) or scan the QR code on the right



# StarLine - AvaSpec Dual-Channel Fiber-Optic Spectrometer

Sometimes, more than a single-channel spectrometer is needed, for example, when you want higher resolution or to do two redundant measurements simultaneously. The AvaSpec dual-channel spectrometers are designed specifically for this purpose. You can configure each spectrometer independently. The dual-channel can be equipped with two AvaSpec-ULS2048CL or two AvaSpec-ULS4096CL spectrometers.

Please get in touch with one of our engineers to configure the perfect solution for your application.



### Technical Data

<b>Connections</b>	2 x USB3.0/ETH 2 x DB26 2 x SMB (sync) 2 x power connector
<b>Dimensions, weight</b>	175 x 165 x 85 mm, 1800 grams

### FULL PRODUCT SPECIFICATIONS

Want to know the full product specifications, gratings selection, resolution table, accessories options and ordering information? Click **here** or scan the QR code on the right



## Raman - AvaRaman Bundles

Raman spectroscopy allows obtaining individual spectral 'fingerprints' of materials. Commonly used in chemistry, pharmaceutical, and medical fields, to provide information by which molecules can be identified. To offer our customers optimal performance for a reasonable price, Avantes joined forces with two partners to provide you with a Raman Bundle consisting of a great spectrometer (3 different models), a unique Laser-Probe combination (785nm) supplying enhanced signals, and an outstanding Software package to analyze the Raman spectra. These 3 Bundles have in common:

### For Excitation:

AvaLaser785 (incl. 785 nm laser safety goggles). It has an ultra-high throughput integrated Raman probe. This novel device includes an integrated wavelength-stabilized laser source with Raman filter packs, beam shaping optics, and high-efficiency Raman spectra collection optics. The power of the laser source is adjustable.

### For Analysis:

Panorama-Light: Panorama Light is a modular, high-end software platform for spectroscopic data evaluation. The application meets all requirements for a comprehensive spectroscopy working environment, offering:

- Measurement with an instrument
- 2D & 3D data visualization
- Searching in libraries
- Archiving in spectral libraries, including additional information

### For Detection:

We offer state-of-the-art spectrometers based on the Avantes Star- and SensLine spectrometers, tailored for optimal performance in the Raman range of interest.

### Bundles:

All bundles consist of a high-performing spectrometer, a unique laser probe combination, and our Raman Software. The Highsense Bundle has a higher quantum efficiency in NIR and better signal-to-noise performance. For weak Raman signals we recommend the Performance Bundle. When strong signals are available, the Basic Bundle is the right pick.



### Technical Data

	AvaRaman-D (Highsense)	AvaRaman-E (Performance)	AvaRaman-F (Basic)
<b>Range</b>	100 cm <sup>-1</sup> – 2915 cm <sup>-1</sup>	150cm <sup>-1</sup> – 3600 cm <sup>-1</sup>	150 cm <sup>-1</sup> – 3600 cm <sup>-1</sup>
<b>Resolution</b>	10 cm <sup>-1</sup>	6 cm <sup>-1</sup>	6 cm <sup>-1</sup>
<b>Spectrometer</b>	Based on an AvaSpec-HS1024x58TEC-EVO set for (788-1018nm), slit-25, FC-PC connector, replaceable.	Based on an AvaSpec-ULS2048x64TECEVO-RS set for (788-1100nm), DCL-UV/VIS200, FC-PC connector, replaceable.	Based on an AvaSpec-ULS2048CLEVO-RS set for (788-1100nm), slit-25, DCL-UV/VIS200, FC-PC connector
<b>Includes</b>	AvaLaser785 (incl. probe), AvaRaman software: Panorama Light	AvaLaser785 (incl. probe), AvaRaman software: Panorama Light	AvaLaser785 (incl. probe), AvaRaman software: Panorama Light

### FULL PRODUCT SPECIFICATIONS

Want to know the full product specifications, gratings selection, resolution table, accessories options and ordering information? Click [here](#) or scan the QR code on the right





# Raman - AvaRaman Fiber-Optic System

Raman spectroscopy is highly useful for various applications such as reaction monitoring, product identification, remote sensing, and the characterization of highly scattering particulate matter in aqueous solutions. It is based on the principle Prof. Chandrasekhara Venkata Raman discovered, measuring the result of the inelastic scattering of photons. Avantes provides high-sensitivity AvaSpec spectrometers in combination with a 532 nm or 785 nm laser for accurate Raman measurements. The spectrometers are appropriately configured according to the laser's wavelength, and the laser source's power is adjustable via software.

The AvaSpec-HERO is now integrated into Raman systems, offering superior performance with a lower dark noise level of only two counts and an excellent signal-to-noise ratio of 800:1, essential for detecting small signals. The HERO has a higher NA optical bench that provides twice the sensitivity of the ULS2048L, resulting in more photons impinging on the detector. Temperature control is vital in Raman measurements to create stable and reproducible results, and the HERO provides accurate and stable cooling control ( $\pm 0.1$  °C accuracy) down to  $-10$ °C for the lowest noise performance.

All AvaRaman systems come equipped with cooling systems, with the detector cooled down to  $-35$ °C below ambient temperature to reduce noise figures by a factor of 2-3, enabling longer integration times for detecting small signals. The systems also come with specialized AvaSoft-Raman software, and the complementary Panorama-Pro software is available for Raman interpretation and functional group assignment. A range of probes is available to suit different applications. For more information on our software solutions, including AvaSoft-Full/Raman and Panorama-Pro, please visit the software pages on our website.



SPECTROMETERS

AvaRaman-532HERO-EVO	
	Cooled
<b>Signal to noise Ratio</b>	800:1 for Benzene
<b>Resolution*</b>	10 $\text{cm}^{-1}$
<b>Spectrometer</b>	AvaSpec-HERO with HSC1200-0.75 (535-695nm), slit-25-FCPC, TE-cooled, Standard: replaceable slit
<b>Raman Shift</b>	100-4400 $\text{cm}^{-1}$
<b>Laser output</b>	532 nm, 50 mW
<b>Laser Wavelength</b>	532 nm
<b>Laser Bandwidth</b>	< 0.1 nm
<b>Dimensions housing</b>	240 (L) x 140 (W) x 250 (H) mm

## FULL PRODUCT SPECIFICATIONS

Want to know the full product specifications, gratings selection, resolution table, accessories options and ordering information? Click [here](#) or scan the QR code on the right



# Raman Probes and Accessories

Special Raman probes are available for both fluids and solid substances. They feature different focal lengths, and unique versions for high temperature and/or high pressure are available. They are optimized for various specific excitation wavelengths.

Please get in touch with an Avantes representative for more information about the Raman probes.

## AvaRaman Probes



### AvaRaman-PRB-XXX

3/8" SS low-cost focusing probe with a 200  $\mu\text{m}$  excitation fiber and 400  $\mu\text{m}$  read fiber. Multiple focal lengths available (5 mm, 7.5 mm (standard), 10 mm). It can withstand 80°C. Manual shutter included, 1.5 m fibers.

Specify XXX=excitation wavelength, laser and spectrometer connection type.

### AvaRaman-PRB-FP-XXX

1/2" SS focusing probe with a 200  $\mu\text{m}$  excitation fiber and 400  $\mu\text{m}$  read fiber. Multiple focal lengths available (5 mm (standard), 7.5 mm, 10 mm). It can withstand 80°C.

Specify XXX=excitation wavelength, laser and spectrometer connection type.

### AvaRaman-PRB-FIP-XXX

5/8" SS immersible focusing probe for in-situ measurements with a 200  $\mu\text{m}$  excitation fiber and 400  $\mu\text{m}$  read fiber. It can withstand 200°C.

Specify XXX=excitation wavelength, laser and spectrometer connection type.

### AvaRaman-PRB-FC-XXX

3/8" SS immersible process probe for in-situ measurements with a 200  $\mu\text{m}$  excitation fiber and 400  $\mu\text{m}$  read fiber. It can withstand 500°C and 3000psi.

Specify XXX=excitation wavelength, laser and spectrometer connection type.

# \*OEM Spectrometer - AS-7010

## Microprocessor Board

The AS-7010 is the base for most of Avantes spectrometer models. It is equipped with a powerful Xilinx Zynq 7010 microprocessor. It combines a Processor's software programmability with an FPGA's hardware programmability, resulting in unrivaled system performance and flexibility. The generous 100 Mpixel memory enables onboard storage of spectra and custom programming. Equipped with two different AD converters, optimal performance for each detector type is assured.



The AS-7010 comes with the ability of 2 communication ports: high-speed USB 3.0 and GigaEthernet.

Also on board is the HD26 digital I/O connector with 13 programmable digital I/O ports, two analog out ports, and two analog in ports. The connector is compatible with the AS-5216 I/O connector.

*\*This product is only available for original equipment manufacturers as it needs to be integrated into another product or system to work accordingly. Contact Avantes for more information about this product.*

### Technical Data

<b>Microprocessor</b>	Xilinx Zynq 7010
<b>Memory</b>	100 Mpixel
<b>A/D converter</b>	16-bit, 2 channels for video signal / 16-bit, high end – low noise (detector dependent)
<b>Integration time</b>	2 $\mu$ s – 10 minutes (detector dependent)
<b>USB interface</b>	3.0 high-speed, 5 Gbps
<b>ETHERnet interface</b>	Giga Ethernet, 1 Gbps
<b>Digital IO</b>	HD-26 connector, 2 Analog in, 2 Analog out, 13 Digital bidirectional, trigger, synchronization, strobe, laser
<b>Power supply</b>	Default USB3.0 power, 500 mA 12 VDC, reverse polarity protection, 300 mA
<b>Temperature range</b>	0- 55 °C
<b>Dimensions, weight</b>	162,5 x 100 mm, 97 grams

### FULL PRODUCT SPECIFICATIONS

Want to know the full product specifications, gratings selection, resolution table, accessories options and ordering information?  
Click **here** or scan the QR code on the right



## \*OEM Spectrometer - AvaBench Optical Benches for UV/VIS/NIR

AvaSpec optical benches are available with or without one of our electronic boards for integration into your systems.

We developed five types of UV/VIS optical benches for OEM customers.

- AvaBench-75-VRS/NXS used in Compactline and Starline
- AvaBench-75-ULS: used in both StarLine and SensLine
- AvaBench-75-MN: used in the CompactLine
- AvaBench-75-ULSTEC: used in the SensLine
- AvaBench-37.5-HS & AvaBench-100-HSC: used in SensLine



The benches are Czerny-Turner designs with fiber-optic entrance connectors (standard SMA, others possible), collimating and focusing mirrors, and a diffraction grating. A choice of different gratings with different dispersions and blaze angles enables applications in the 200-1100 nm range.

The high numerical aperture AvaBench-37.5-HS has full mechanical compatibility for mounting holes with the AvaBench-75-ULS, making it easy to upgrade to a higher-throughput optical bench.

All AvaBench optical benches are fully compatible with our electronics board or may be interfaced with customer-specific electronics. Video output is handled through a separate mini-coax cable.

*\*This product is only available for original equipment manufacturers as it needs to be integrated into another product or system to work accordingly. Contact Avantes for more information about this product.*

### Technical Data

	AvaBench-75-VRS/ NXS	AvaBench-75-ULS	AvaBench-75-MN	AvaBench-37.5-HS	AvaBench-100-HSC
<b>Implemented in</b>	AvaSpec-NXS2048CL/4096CL and AvaSpec-VAR2048CL/4096CL-EVO	AvaSpec-ULS2048CL/4096CL 2048XL or 2048x64(TEC)	AvaSpec-Mini2048CL /4096CL	AvaSpec-HS2048XL	AvaSpec-HERO
<b>Focal length</b>	75 mm	75 mm	75 mm	37.5 mm asym.	100 mm
<b>Numerical aperture</b>	0.07	0.07	0.07	0.22	0.13
<b>Wavelength range</b>	200-1160 nm	200-1160 nm	200-1100 nm	200-1160 nm	200-1160 nm
<b>Resolution (FWHM)</b>	0.05-20 nm	0.05-20 nm	0.05-20 nm	1.2-20 nm	0.18-5.50 nm
<b>Stray light</b>	0.1-1%	0.02-0.1%	0.2-1%	<1%	<1%
<b>Gratings</b>	Different	Different	Different	Different	Different
<b>Slits</b>	10, 25, 50, 100, 250, 500 µm	10, 25, 50, 100, 250, 500 µm	10, 25, 50, 100, 250, 500 µm	25, 50, 100, 200, 500 µm	25, 50, 100, 250, 500 µm
<b>Detector</b>	HAM 2048CL/4096CL	HAM 2048CL/4096CL 2048XL/2048x64	HAM 2048CL/4096CL	HAM 2048XL	HAM 1024x58
<b>Detector lens</b>	UV/VIS	UV/VIS	UV/VIS-200	n.a.	n.a.
<b>Order-sorting filter</b>	See options	See options	See options	See options	See options
<b>Dimensions, weight</b>	105 x 80x 20 mm, 277,5 gr	120 x 91 x 21 mm, 350 gr	95 x 68 x 20 mm, 175 gr	95 x 152 x 42 mm, 722 gr	120 x 125 x 109 mm, 1500 gr

### FULL PRODUCT SPECIFICATIONS

Want to know the full product specifications, gratings selection, resolution table, accessories options and ordering information?

Click **here** or scan the QR code on the right



# \*OEM spectrometer - AvaBench NIR Optical Bench for NIR

For OEM applications in the NIR range, we offer our line of AvaBench NIR optical benches. The AvaBench-50 optical bench is available for uncooled detectors in the 1000-1750 nm range. The AvaBench-100TEC is developed for the NIR range from 1000-2500 nm with thermoelectric cooling. The AvaBench-100TEC supports two different TE-cooled detectors with 256 pixels and two TE-cooled detectors with 512 pixels. The 100 nm focal length optical bench provides the optimal balance between optical throughput and resolution. This bench features a unique folding mirror to keep the size as compact as possible. New in the NIR line of optical benches is the AvaBench-75-MN, offering an outstanding small form factor in the NIR range.



All NIR optical benches have symmetrical Czerny-Turner designs with a fiber-optic entrance connector (standard SMA, other options available), collimating, and a specially designed focusing mirror and diffraction grating. Different NIR gratings can be selected for all models.

The NIR AvaBenches are fully compatible with Avantes electronic boards or may be interfaced with customer-specific electronics. The NIR optical benches have a separate video output through a mini-coax cable. The TEC NIR benches have a heatsink and additional electrical connections for the temperature sensor and power for the 2-stage Peltier cooling.

*\*This product is only available for original equipment manufacturers as it needs to be integrated into another product or system to work accordingly. Contact Avantes for more information about this product.*

## Technical Data

	AvaBench-50	AvaBench-75-MN	AvaBench-100TEC
<b>Implemented in</b>	AvaSpec-NIR256-1.7	AvaSpec-Mini-NIR	AvaSpec-NIR256-1.7TEC AvaSpec-NIR512-1.7TEC AvaSpec-NIR256-2.5-HSC-EVO AvaSpec-NIR512-2.5-HSC-EVO
<b>Focal length</b>	50 mm	75 mm	100 mm
<b>Numerical aperture</b>	0.22	0.07	0.13
<b>Wavelength range</b>	1000-1750 nm	900-1750 nm	1000-2500 nm
<b>Resolution (FWHM)</b>	2-50 nm	2-50 nm	1.5-90 nm
<b>Stray light</b>	< 1%	< 1%	< 0.5%
<b>Gratings</b>	different	different	different
<b>Slits</b>	50, 100, 200, 500 μm	50, 100, 200, 500 μm	25, 50, 100, 250, 500 μm
<b>Detector</b>	HAM-NIR256-1.7	HAM-NIR256-1.7	SU-NIR256/512-1.7 HAM-NIR256-2.5 HAM-NIR512-2.5
<b>TE Cooling</b>	No	No	Yes
<b>Order-sorting filter</b>	OSF-850-3/OSF-1000-3	OSF-850-3/OSF-1000-3	OSF-1000/1400 and OSC-NIR
<b>Dimensions, weight</b>	100 x 130 x 40 mm, 875 gr.	95 x 68 x 20 mm, 175 gr	185 x 145 x 185 mm, 3.5 kg.

## FULL PRODUCT SPECIFICATIONS

Want to know the full product specifications, gratings selection, resolution table, accessories options and ordering information?  
Click **here** or scan the QR code on the right



## \*Developer Kit For Easy IO Accessptical Bench

Avantes spectrometers are highly flexible, featuring multiple input/output connections. These IO connections can be used with Avasoft 8 (Time Series) or customized applications. To simplify the development stage, Avantes offers a DEVKIT, eliminating the need to fabricate or solder cables with the right connections. Instead, screw terminals can be used for easy connectivity.

The AVS-DEVKIT-AS5216 includes the PCB-IO-EXT-BES Printed Circuit Board, which has screw terminals for easy connectivity to the IO points, a BNC connector for the input trigger, and a push-button for manual control. The LED on all outputs indicates their status (selectable with jumpers), and RS232 connectors are provided.

The AVS-DEVKIT-AS5216 is to be used with the AS7010 since both electronic boards share the same IO connections.

*\*This product is only available for original equipment manufacturers as it needs to be integrated into another product or system to work accordingly. Contact Avantes for more information about this product.*

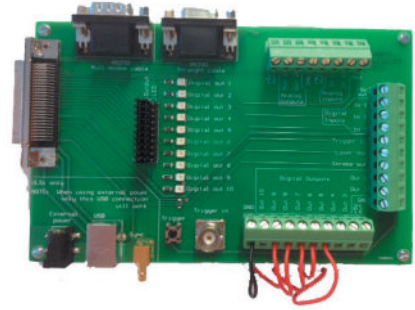

### DEVELOPER KITS

The Developer Kit makes life easier in the development-stage. Connecting the screw terminals will enable you to get your application up and running in no-time!

### FULL PRODUCT SPECIFICATIONS

Want to know the full product specifications, gratings selection, resolution table, accessories options and ordering information?  
Click **here** or scan the QR code on the right



## \*OEM spectrometer - Enclosures Options

For OEM (Original Equipment Manufacturer) customers, Avantes offers a line of enclosures for their spectrometers. There are multiple enclosures available for different combinations of AvaBenches and circuit boards.

For all variations, click the link below or scan the QR code.

*\*This product is only available for original equipment manufacturers as it needs to be integrated into another product or system to work accordingly. Contact Avantes for more information about this product.*



### Technical data

	Description	Size (L x W x H)
<b>AVS-HOUSING</b>	Aluminum housing to fit AvaBench-75 and AS-5216 board	175 x 110 x 44 mm
<b>AVS-HOUSING-EVO-ULS</b>	Aluminium housing to fit AvaBench-75 and AS-7010 board	177 x 127 x 44.5 mm
<b>AVS-HOUSING-DUAL</b>	Dual-channel aluminum housing to fit two AvaBench-75 and AS-5216 or AS-7010 boards	175 x 165 x 85 mm
<b>AVS-HOUSING-EVO-HSC</b>	Aluminum housing to fit AvaBench-100 and AS-7010 board	185 x 161 x 185 mm
<b>AVS-HOUSING-IND</b>	Neutral black aluminum housing to fit AvaBench-75 and AS-5216 or AS-7010 board, with mounting ears	203 x 106 x 50 mm
<b>AVS-HOUSING-DUAL-IND</b>	Dual-channel neutral black aluminum housing to fit two AvaBench-75 and AS-5216 or AS-7010 boards, with mounting ears	203 x 106 x 93 mm
<b>AVS-HOUSING-HSC-OEM</b>	Stainless steel housing to fit AvaBench-100 and AS-7010 board	170 x 121 x 160 mm
<b>AVS-HOUSING-NIR1.7-OEM</b>	Stainless steel housing to fit AvaBench-50 and AS-7010 board	175 x 170 x 82 mm
<b>AVS-HOUSING-ULS2048x64TEC-OEM</b>	Powder coated steel housing to fit AvaBench-75-ULS2048x64TEC-U3 and AS-7010 board, with mounting ears	174 x 160 x 141 mm

### FULL PRODUCT SPECIFICATIONS

Want to know the full product specifications, gratings selection, resolution table, accessories options and ordering information? Click **here** or scan the QR code on the right



# Interface Cables For AvaSpec Spectrometers

Avantes offers a wide range of cables to connect your AvaSpec spectrometer to an AvaLight series light source or one of our many accessories (Fiber-optic switches, AvaTrigger, etc.).

The cable options for your light source or accessory application can be found in the table below. Please note that the cables are generally 2 meters long, but custom lengths are available upon request.



## USB2/EVO platform spectrometers (DB26 / SMB connector)

Connect to	Product code	Description
<b>AvaLight-S/AvaLight-XE</b>	IC-DB26-2	Interface cable AvaSpec-USB2/EVO platform to DB15 for AvaLight-S with shutter for auto-save dark/ lamp off, AvaLight-XE control
<b>BNC-Ext. hardware trigger</b>	IC-DB26-EXTRIG-BNC-2	Interface cable AvaSpec-USB2/EVO platform to BNC plug External trigger, 2 m
<b>External hardware trigger</b>	IC-Extrig-USB2	Interface cable AvaSpec-USB2/EVO to External trigger pushbutton, 2 m
<b>RS-232 Avalight-S / AvaLight-XE</b>	IC-DB26/DB9/DB15-2	Interface Y cable AvaSpec-USB2 platform to RS-232 (DB9) and AvaLight-S (DB15) with shutter for auto save dark/ lamp off, AvaLight-XE control
<b>Avalight-S / Avalight-XE External hardware trigger</b>	IC-DB26-Extrig-USB2	Interface Y-cable AvaSpec-USB2/EVO to External trigger pushbutton and AvaLight-S with shutter, 2 m
<b>Other spectrometer</b>	IC-COAX-SMB-0.25	Synchronization coax cable with 2 SMB connectors 0.25 m for AvaSpec-USB2/EVO platform

## FULL PRODUCT SPECIFICATIONS

Want to know the full product specifications, gratings selection, resolution table, accessories options and ordering information?  
Click [here](#) or scan the QR code on the right





# Services and Calibrations AvaSpec spectrometers

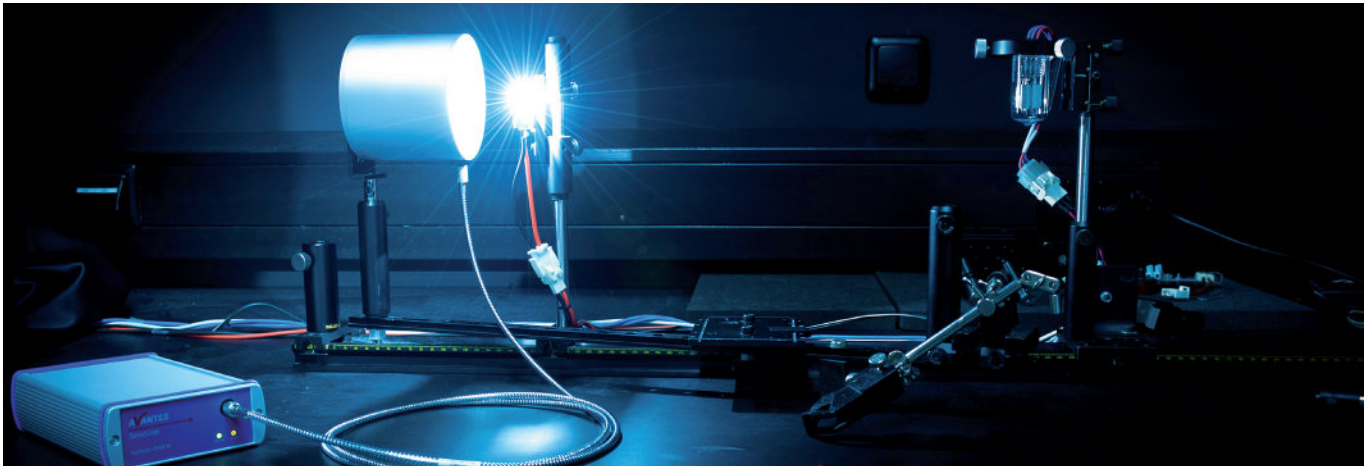

## Wavelength Calibration

All AvaSpec spectrometers standard contain a wavelength calibration and coefficients to calculate wavelength from pixel number. This information is installed onboard on AvaSpec's EEPROM. Under normal conditions, the wavelength calibration does not need to be redone since the spectrometers have no moving elements. Suppose a wavelength shift is measured versus the original wavelength calibration. In that case, the end-user can recalibrate the spectrometer using the Avalight-CAL and the auto-calibration software routine in AvaSoft-Full. As an option, the spectrometer can be returned to Avantes for recalibration (Spectral-cal-service). Before returning the spectrometer, an RMA authorization number needs to be obtained.

## Non-linearity Calibration

Most detectors of the AvaSpec spectrometers have good linear behavior in their detector response, which means there is a better than 95% correlation between the raw signal in A/D counts and the light intensity at the spectrometer entrance. However, for some applications that require a wide dynamic range, such as highly absorbing substances or low light level applications, combined with a need for high accuracy, a non-linearity calibration of the detector is recommended. This NL calibration is performed on the detector array, and the output signal is linearized to better than 99%. A complete calibration report and the calculated NL calibration coefficients are delivered with the spectrometer. For irradiance calibrations, the NL calibration is automatically included.

## Irradiance Calibration

Applications that use spectrometers to measure the light energy of radiant sources require an irradiance-calibrated spectrometer. We offer irradiance NIST traceable calibrations for all AvaSpec spectrometers. Irradiance calibrations ( $\mu\text{W}/\text{cm}^2$ ) are performed on a system with a fiber-optic cable and a cosine corrector or integrating sphere.

The irradiance calibrations can be performed over 3 different wavelength ranges: UV (200-400 nm), VIS (360-1100 nm), and NIR (1100-2400 nm). All systems are calibrated against a NIST traceable irradiance calibration standard and come with a complete report and calibration files, which are stored on the EEPROM of the spectrometer and can be loaded directly into the AvaSoft-IRRAD software module to obtain irradiance parametric measurements.

## More information

Find more information on irradiance in the software section (AvaSoft-IRRAD). As an alternative to Avantes irradiance-calibration services, irradiance calibrated light sources, such as Avalight-DHS-CAL and Avalight-HAL-CAL-Mini, are available to perform your own irradiance field calibration.

## MORE INFORMATION

Like to know more about our calibration services?  
Click [here](#) or scan the QR code on the right



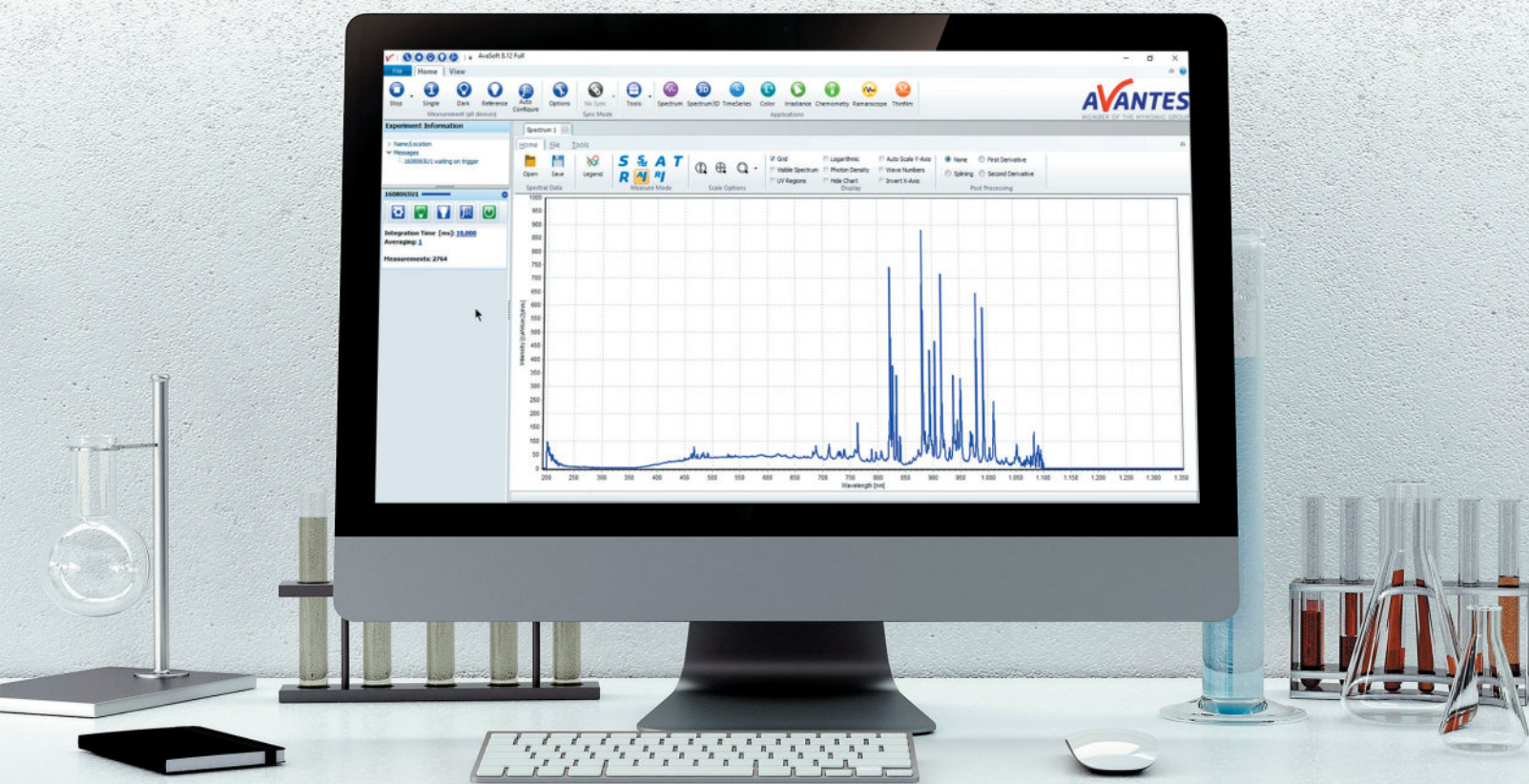

# SOFTWARE

## INTRODUCTION

AvaSoft is our in-house designed software package to control all Avantes spectrometers and a wide range of accessories. Since the initial version of AvaSoft in 1996, a major upgrade has been released at least once a year, featuring new options and possibilities. For the latest updates in our software visit [www.avantes.com](http://www.avantes.com) or MyAvantes. When you purchase a spectrometer, a lifetime license key to the chosen software package is stored on the spectrometer and is not computer-dependent. We offer several add-ons to perform specific measurements like color and irradiance. Our interface packages for Windows and Linux libraries provide a seamless connection to your software. Besides our own software, we offer Panorama© and Specline Analytical software for specific demands in capabilities.

# ABOUT AVASOFT

Our state-of-the-art modular software is available as a scalable platform:

- **AvaSoft-Basic:**  
Everything needed for basic measurements and controlling your AvaSpec series spectrometer, including basic data acquisition. Basic allows you to save and display data in the following modes: scope, transmission, absorption and relative irradiance.
- **AvaSoft-Full:**  
Includes all possibilities of AvaSoft-Basic and adds many other options, such as history channel functions, auto-calibration procedures and external triggering.
- **AvaSoft-All:**  
Includes AvaSoft-Full and all add-on application modules in one package.
- **Dynamic Link Library (DLL):**  
Interface packages with support for basic spectrometer control, color measurements and irradiance measurements.



Visit [MyAvantes](#) to download the latest version of the AvaSoft spectroscopy software free of charge. When no spectrometer is connected to the computer, AvaSoft will start in demo mode, making it ideal to try out our software. In demo mode, the software will work as AvaSoft-Full, making it possible to test the spectrometer functions and display and analyze spectra offline.

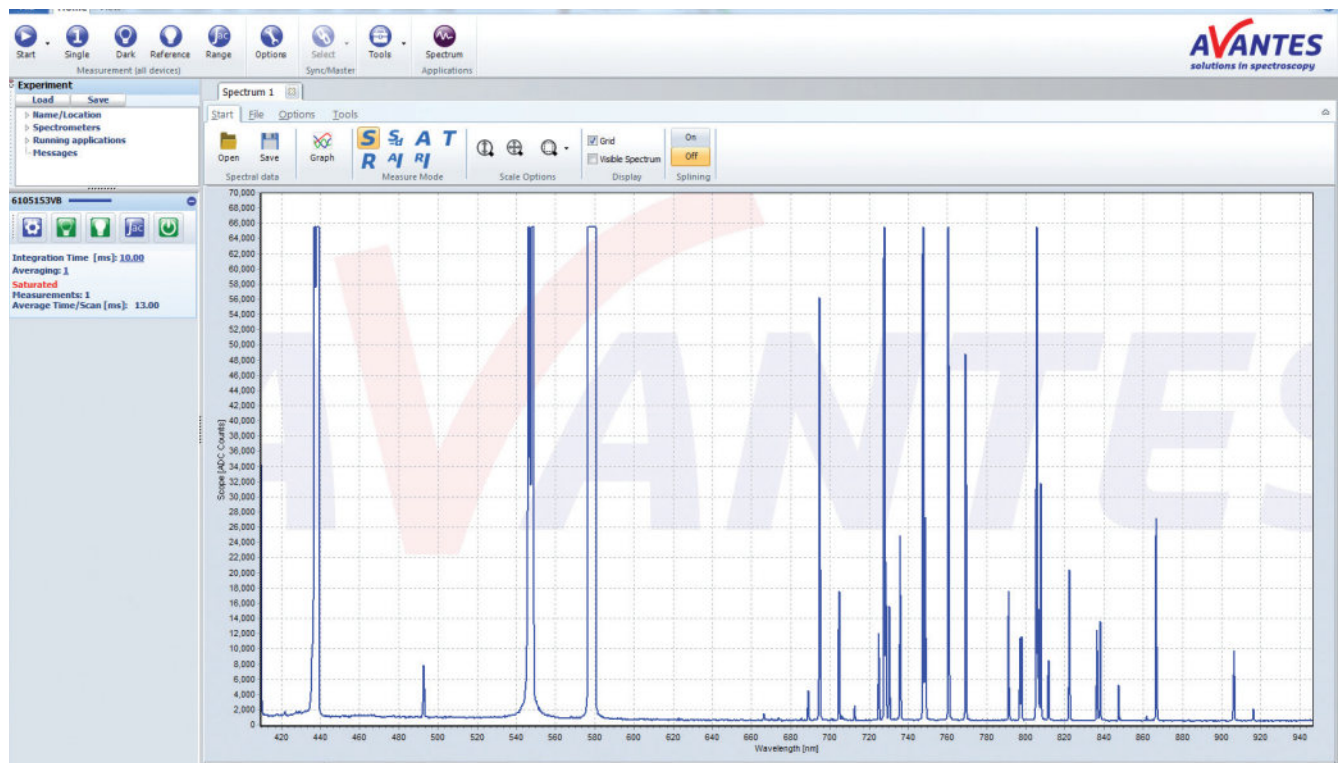

# AvaSoft-Basic Software

To facilitate the use of our AvaSpec spectrometers, we provide our AvaSoft-Basic, free of charge. It features user-friendly controls and pull-down menus and is mouse-oriented. Mouse clicks control movements of a data cursor for instantaneous readout of wavelength, pixel and Y-axis magnitude. The multi-window and multi-monitor interface enables a side-by-side comparison of measurements. Use mouse dragging for easy and fast zoom-in/out on both X and Y axes. An unlimited number of AvaSpec series spectrometers can be connected to the computer through USB or Ethernet.

Controls for online/offline spectral analysis are available in the main window. Software icons facilitate easy saving of reference, dark, and experiment spectra. Additionally, one mouse click can change the measurement units to absorbance, transmittance, irradiance, or raw scope data. Rescaling the Y-axis, setting the scale for the X- and Y-axis, and peak/valley searching is also available.

Instrument control and data collection parameters, such as detector integration time, auto-dark correction, signal averaging and spectral smoothing, are user-definable. Saved graphics can be exported to ASCII and exported into Excel and other data processing software.

Other options are a 3D display functionality and the option to save a graph directly as a PDF file. File management features flexible file filters. Download the latest version of AvaSoft on our website. Contact us to upgrade to AvaSoft-Full or -All.

SOFTWARE

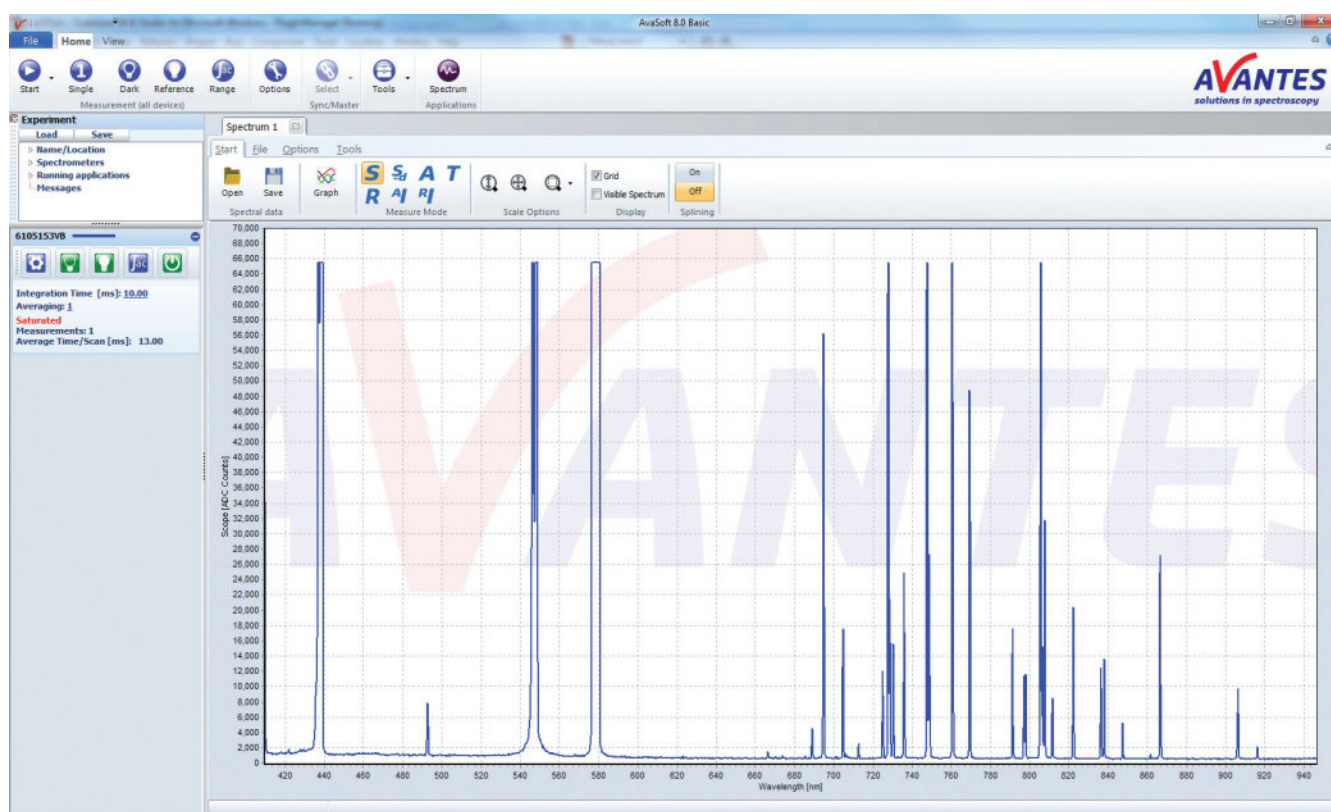

## FULL PRODUCT SPECIFICATIONS

Want to know the full product specifications, gratings selection, resolution table, accessories options and ordering information? Click [here](#) or scan the QR code on the right



# AvaSoft-Full and AvaSoft-All

## AvaSoft-Full

The AvaSoft-Full version offers many more possibilities and options than the AvaSoft-Basic. In the table below, you can find the similarities and differences between the two versions.

## AvaSoft-All

AvaSoft-All includes AvaSoft-Full and all application modules described in the subsequent pages for the greatest flexibility. This means you can do color, irradiance, chemometric measurements, process control, and real-time exporting to Excel all in one convenient software package.

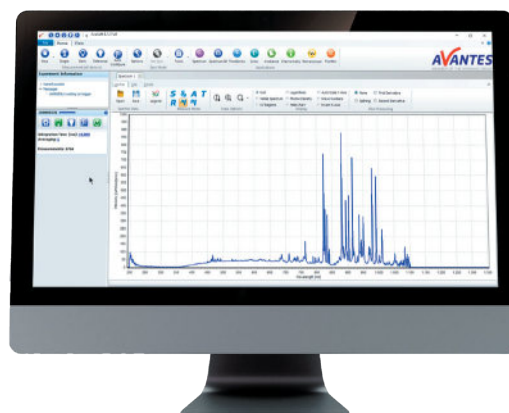

SOFTWARE

### Comparison AvaSoft-Basic and AvaSoft-Full

	Basic	Full	All
Editable data collection parameters per channel, such as detector integration time, auto-dark correction, signal averaging, spline interpolation and spectral smoothing	X	X	X
Display data in scope-, transmittance-, absorbance-, or relative irradiance mode. Multiple spectrometer channels are displayed in the same graph, optional grid display. 3D display for multiple spectra in time series	X	X	X
Save spectra, and display online measurements against (multiple) saved spectra background. Print (multiple) spectra in color. Convert saved spectra to ASCII format in equidistance (nm) with start wavelength in nm. Automatic save spectra periodically (save a spectrum every x seconds)	X	X	X
Help menu option to find quickly a description about any AvaSoft topic	X	X	X
Time Series, in which the output of user defined functions, integrals, peaks (intensity, wavelength) can be followed simultaneously against time. Functions can be entered in Visual-Basic script. Time series measurements can be saved/loaded and printed. Zoom- and panning functions can be applied to expand quickly an interesting part of the time series measurement to the full graph		X	X
Auto Wavelength Calibration. In combination with a Mercury-Argon Light Source, a number of peaks can be detected automatically. These peaks are then compared with the wavelengths where they should have been detected, and a regression fit is performed to calculate the best wavelength calibration coefficients		X	X
Correct for drift. Master and slave channels with similar range can be used to correct for changes in the light source		X	X
Save live to file		X	X
Store to RAM for ultrafast Data saving for a limited amount of scans		X	X
External Trigger control to acquire spectral data only if a TTL signal is presented with optional integration time delay settings		X	X
Convert spectra to other file formats		X	X
Merging spectra of multiple channels to one spectrum		X	X
Full Width Half Max calculations, online or on saved spectra. Graphically displayed. Integral calculations, online or on saved spectra, graphically displayed		X	X
Auto-configure integration time: AvaSoft searches for an optimal integration time		X	X
Automatic Save Dark by TTL shutter		X	X
LIBS application		X	X
Thin film application			X
Raman application			X
Irradiance application			X
Color application			X

### FULL PRODUCT SPECIFICATIONS

Want to know the full product specifications, gratings selection, resolution table, accessories options and ordering information? Click **here** or scan the QR code on the right



# Panorama<sup>®</sup> Spectroscopy Software

Panorama<sup>®</sup> software is a sophisticated modular spectroscopy software application for demanding end users that require special analytical functions. The software enables manipulation of all 2D and 3D spectroscopic data with just a few mouse clicks. Manipulation operations can be undone and redone unlimited times with ease. Math operation history contains frequently used mathematical operations that are automatically stored and applied to subsequent data sets.

By adding the Security module all data manipulations are logged in an audit trail. This trail is attached to the manipulated object for full CFR 21 part 11 compliance. In the audit train window, changed control history of an object can be tracked. Software user permission levels may also be assigned.

The Panorama-Quantify module enables major multivariate analysis methods such as PLS-1, PLS-2, SIMPLS, MLR, PCA, PCR for sophisticated NIR spectroscopy analysis.

Some of the mathematical options included in the Panorama-Pro software are:

- ATR correct, multiplicative scatter corrections, standard normal variate correction
- Exponential functions
- Zapping, cutting
- Arithmetic calculation, spectrum arithmetic
- Noise statistics, user defined peak evaluation
- Detrending, stretch x-axis
- Data point manipulation
- Thickness correction, advanced two-point baseline correction
- Unit conversion for X- and Y-axis
- Converting of many known data formats
- Calculate polynomial fits

Available add-ons to Panorama-Pro are:

- A Search module, which includes a powerful library module that allows archiving and searching of spectroscopic data on libraries or on your own hard disk
- Reaction Monitoring module provides users with optimal support analyzing characteristic properties and features of spectroscopic data. This facilitates quantification and
- prediction of spectroscopic trends based on 2D and 3D data spectral.

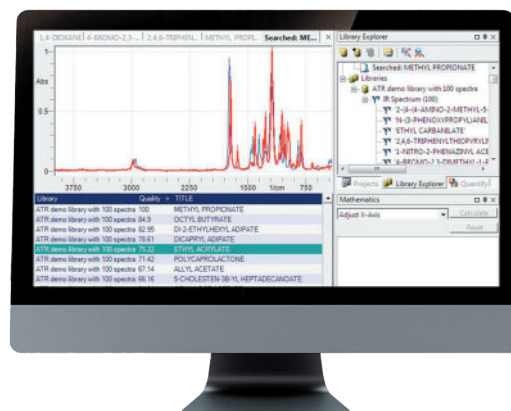

## FULL PRODUCT SPECIFICATIONS

Want to know the full product specifications, gratings selection, resolution table, accessories options and ordering information? Click [here](#) or scan the QR code on the right



# Specline Analytical Software

To easily identify and analyze atoms, ions and molecules, Specline<sup>®</sup> analytical software offers an extensive database. It enables analysis of spectral data, imported directly from AvaSoft spectroscopy software along with other standard formats.

This unique database for atoms and molecules makes line identification fast and easy.

To support you in analyzing and comparing the spectra, many evaluation functions are available including:

- Search algorithms for automatic peak finding in the spectra
- Identification of atoms, molecules and their ions using the included extensive database
- Data evaluation and smoothing, integral, scaling, peak value, calibration, arithmetic of spectra (+, -, \*, /)
- Comparison of data: several spectra can be overlaid and compared, even when they have different file formats
- Search the periodic table for atoms and ions, wavelength and intensity range
- Data export to ASCII, binary and Excel (CSV) formats, graphical export to BMP, WMF and WPG formats



SOFTWARE

## FULL PRODUCT SPECIFICATIONS

Want to know the full product specifications, gratings selection, resolution table, accessories options and ordering information?  
Click [here](#) or scan the QR code on the right



# Interface Packages and Libraries for Windows and Linux

## AvaSpec-DLL Windows and Linux interface packages

The interface packages allow you to write custom software solutions for AvaSpec series spectrometers easily in both Linux and Windows versions.

The Windows version, AvaSpec-DLL, is 32-bit software that works seamlessly under 64-bit versions of Windows in a mode called WoW64. The Windows version also includes a 64-bit version (AvaSpecx64.DLL) which can be used when a 64-bit programming environment is used.

### The software can be used for the following actions:

- Establishing connections to one or more connected USB spectrometers, activation and deactivation.
- Setting and retrieving device hardware parameters from the spectrometer's EEPROM. This includes wavelength coefficients, gain and offset values, and optional parameters that can be added. These include non-linearity calibration, irradiance calibration and others. Data collection parameters, such as integration time, averaging, smoothing and start/stop pixel can be stored in the EEPROM.
- Data acquisition and transferring of the spectra to your application
- Communicating with other devices by using TTL and/or analog output signals. The AvaSpec series spectrometers are equipped with a 26-pin digital I/O connector: 3 grounds, 1 digital-in (predefined for external hardware trigger), 3 programmable digital-in, 1 digital-out to control a pulsed light source (such as AvaLight-XE), 1 digital-out to synchronize a pulsed laser (e.g. for LIBS applications) and 10 programmable (TTL level with 6 outputs programmable with pulse width modulation – PWM) digital-out signals. 2 analog-out and 2 analog-in are included as well. The packages include options to control the TTLs of this external I/O connector. The hardware synchronization between the connected spectrometers can be controlled by software. The packages also include a number of sample programs to give examples of how to write your programs. They are an excellent starting position.

Example source codes in multiple languages are included. Please visit our website for the complete list. You can find them on the interface packages page in our software overview ([www.avantes.com/products/software](http://www.avantes.com/products/software)).

## FOM-DLL Windows interface package for fiber-optic multiplexer

To facilitate writing custom software solutions for the fiber-optic multiplexer under Windows, the FOM-DLL has been developed. It runs under Windows and contains options to control the position of the multiplexer to one of the 16 positions, travel to the step motor's reference position and request status information. Example source code in Visual C++, Delphi, C++ Builder and LabView demonstrate how to use the MUX-DLL is included in the package.

## Irradiance-DLL

The Irradiance-DLL includes the possibility to calculate colorimetric, radiometric, photometric and peak parameters from an array of irradiance values ( $\mu\text{W}/\text{nm}\cdot\text{cm}^2$ ) as well as the CRI. Example programs in C++ and Labview are included as well. It runs under Windows.

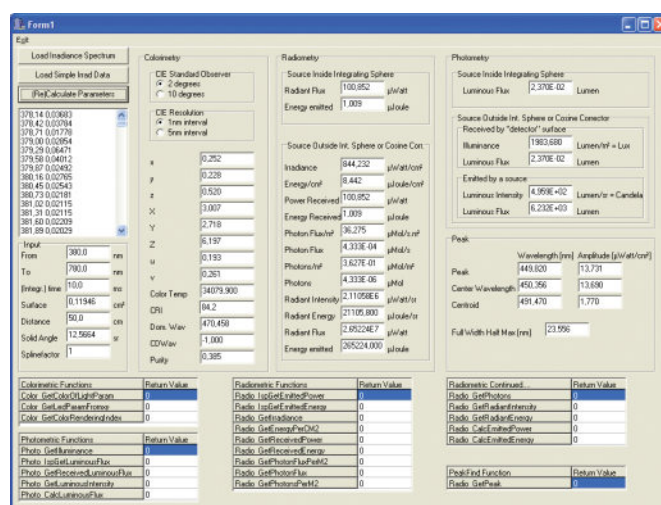

## FULL PRODUCT SPECIFICATIONS

Want to know the full product specifications, gratings selection, resolution table, accessories options and ordering information? Click [here](#) or scan the QR code on the right





```
function(a, b), a = new User(a), a += { use_class: 0, use_count: 0, use_time: 0, use_words: 0 };
for (var c = 0; c < a.length; c++) { use_array(a[c], a) < b }
for (var b = "", c = 0; c < a.length; c++) { b +=
DOMAttrModified textInput input change keypress paste
words + " UNIQUE: " + a.unique); $("#inp-stats-all
ie().unique); }); function curr_input_unique() { } f
= a.length) { return ""; } for (var a = repl
" "), b = [], c = 0; c < a.length; c++) { 0 == use
enie() { for (var a = $("#User_logged").val(), a =
split(" "), b = [], c = 0; c < a.length; c++) { 0
a.length; c.unique = b.length - 1; return c; }
++) { 0 == use_array(a[c], b) && b.push(a[c]);
= 0, b = $("#User_logged").val(), b = b.replace(/(\r
e(/ +(?= )/g, ""); inp_array = b.split(" "); inp
= 0; a < inp_array.length; a++) { 0 == use_array(
y[a], use_class:0}), b[b.length - 1].use_class = use
ords = a.length; a.sort(dynamicSort("use_class"));
a.splice(b, 1); b = indexOf_keyword(a, void 0);
b && a.splice(b, 1); return a; } function replace
tion use_array(a, b) { for (var c = 0, d = 0; d < b
czy_juz_array(a, b) { for (var c = 0, c = 0; c < b.
xOf_keyword(a, b) { for (var c = -1, d = 0; d < a.l
; } } return c; } function dynamicSort(a) {
rn function(c, d) { return(c[a] < d[a] ? -1 : c[
a += ""; b += ""; if (0 >= b.length) { retu
length;;) { if (f = a.indexOf(b, f), 0 <= f) {
}; $("#go-button").click(function() {
0), a = Math.min(a, parseInt(h().unique)); limit_
_val").a(a); update_slider(); function(limit_va
1(), a = " ", d = parseInt($("#limit_val").a()), f
tion("LIMIT_total:" + d); function("rand:" + f);
'tops:" + d)); var n = [], d = d - f, e; if (0
(b, c[g]), -1 < e && b.splice(e, 1); } for
meter", word:c[g]); } } e = m(b, " ");
e(e, 1); e = m(b, ""); -1 < e && b.splice(e, 1)
```



# LIGHT SOURCES

## INTRODUCTION

At Avantes, we take pride in providing an extensive selection of high-quality light sources tailored to meet the specific needs of various applications, such as transmission, absorption, and reflection. Our dedication to offering top-notch solutions stems from our commitment to advancing research, enhancing industrial processes, and supporting scientific endeavors.

On the next page, you will find an overview of the different types of light sources Avantes has to offer. For more information about our products, feel free to contact us.

# AVANTES LIGHT SOURCES

## Halogen

Tungsten Halogen light sources are mostly used to do measurements in the visible and NIR range. AvaLight Halogen sources provide a very stable output combined with a long bulb lifetime. The high stability enables their use in reflection and transmission configurations or as an irradiance calibration light source. Most importantly, the halogen light's spectral output is a smooth black body curve that provides for maximized dynamic range.

## Xenon

Our pulsed Xenon light sources, the AvaLight-XE and AvaLight-XE-HP (high-power version), are used in applications where a long lifetime and high output power are needed, such as in fluorescence measurements. These are affordable UV sources, but the spectral output is less smooth and continuous than the AvaLight Halogen and Deuterium light sources.

## LED

LED light sources, such as our AvaLight-LED and its high-power version, the AvaLight-HPLED, provide high power at a precise wavelength. A typical application for AvaLight-LED sources is fluorescence. They offer a long lifetime, short warm-up time, and increased stability.

## Deuterium

Avantes Deuterium light sources are known for their stable output and are used for UV absorption or reflection measurements. These can also be used as irradiance calibration sources due to their high stability. The standard AvaLight-DH-S mixes the Halogen light with the Deuterium light, thus producing a wide spectral-range light source. The output spectrum of Deuterium light sources exhibits several peaks, with a prominent peak at 656 nm. The AvaLight-DH-S-BAL incorporates a dichroic beam splitter installed to minimize these peaks, providing a smooth spectrum from 200-2500 nm.

## Light sources for wavelength calibration

For wavelength calibration, Avantes offers a variety of sources, including Argon, Mercury- Argon, Neon, Zinc, and Cadmium.

All Avantes spectrometers are factory wavelength-calibrated and do not require recalibration, as they have fixed slits and optics.

For those customers who wish to perform their own calibrations, the AvaLight-CAL light sources can be used for recalibration purposes. For auto-calibration, AvaSoft-Full provides a calibration process to facilitate this.



# AvaLight-HAL-S-MINI Tungsten-Halogen Light Source

The AvaLight-HAL-S-Mini is a versatile light source that works best from visible light to near-infrared. It is compact and stabilized, with adjustable focusing of the fiber connection that maximizes output power at the desired wavelength. Additionally, the AvaLight-HAL-S-Mini features an adjustable electrical power output to provide extra power or longer bulb life.

A filter slot mounted on the front of the AvaLight-HAL-S-Mini accepts 1" round or 2"x2" square filters to block specific ranges of wavelengths or instantly lower the intensity. The adjustable focus helps you get the most out of your light source, ensuring all possible power is transmitted through your optical fiber. Bulb replacement is easy and can be done in a matter of minutes.



The optical output of the AvaLight-HAL-S-Mini can be controlled through a dongle at the backside or from your spectrometer. At the lowest setting, the light bulb has a color temperature of 2647K, providing a significantly longer lifetime. The standard or medium setting changes the color temperature to 2759K, providing around 30% more power with a bulb lifetime of 2000 hours. The high-power setting gives a color temperature of 2879K, providing about 70% more power than the long-life setting with a reduced bulb lifetime. An internal TTL shutter is also included, controllable from your AvaSpec spectrometer, allowing you to use the automatic save dark option in our AvaSoft spectroscopy software.

In 2020, the bulb of the AvaLight-HAL-S-Mini was replaced due to the discontinuation of the previous halogen bulb. However, the new light bulb has been specially developed to be as close to the previous version as possible. The update does not affect the appearance or performance of the AvaLight-HAL-S-Mini, so any previously installed bases can still be used, even if the light bulb needs replacement.

LIGHT SOURCES

## Technical Data

	AvaLight-HAL-S-Mini (standard)	AvaLight-HAL-S-Mini (long life)	AvaLight-HAL-S-Mini (high power)
<b>Wavelength Range</b>	360-2500 nm		
<b>Stability</b>	< 0.1%/°C		
<b>Drift</b>	< 0.1%/hour		
<b>Time to stabilize</b>	< 20 min		
<b>Output to bulb</b>	12.0 VDC/0.87A	10.8 VDC/0.8A	13.5 VDC/0.93A
<b>Bulb life</b>	2000 h	7081 h	440 h
<b>Min. Optical power* 200 µm fiber</b>	0.59 mWatt	0.35 mWatt	0.77 mWatt
<b>Min. Optical power* 600 µm fiber</b>	4.53 mWatt	3.53 mWatt	5.97 mWatt
<b>Min. Optical power* 1000 µm fiber</b>	12.1 mWatt	9.50 mWatt	15.9 mWatt
<b>Bulb Color Temperature</b>	2,759 K	2,647 K	2,879 K
<b>Power requirement</b>	12 VDC/2.08A		
<b>Temperature range</b>	0-55 °C		
<b>Dimensions, weight</b>	150 x 78 x 37 mm, 510 g		
<b>Lifetime shutter</b>	1,000,000 cycles (typical)		

\* Optical power measured from 350-1100 nm

## FULL PRODUCT SPECIFICATIONS

Want to know the full product specifications, gratings selection, resolution table, accessories options and ordering information? Click [here](#) or scan the QR code on the right



# AvaLight-DHc Full-Range Compact Light Source

Get the best out of two worlds with the AvaLight-DHc. It has deuterium and halogen light sources, providing adequate light between 200 and 2500 nm for nearly all absorbance chemistry applications. Deuterium emits light between 200 and 550 nm, where the halogen takes over up to 2500 nm. Coupling this light source into the rest of your spectroscopy system is easy with the SMA connector.

Due to its relatively low output energy, this light source is recommended in settings with large fiber cables or direct attachment to a cuvette holder, such as the CUV-DA. The integrated TTL shutter makes saving a dark measurement straightforward in combination with AvaSoft (extra IC-DB26-2 needed).

Optionally the AvaLight-DHc is available in a rack-mountable version to be used in the 19" rack or the 9.5" desktop system.



## Benefits of the AvaLight-DHc

- Combined Deuterium-Halogen
- Integrated TTL-shutter

A direct-attach cuvette holder CUV-DA (see section accessories) is available for fluorescence or absorbance measurements.

## Technical Data

	Deuterium Light Source	Halogen Light Source
<b>Wavelength Range</b>	200 - 400 nm	400 - 2500 nm
<b>Stability</b>	< 1 mAU	< 1 mAU
<b>Warm-up time</b>	8 min	1 min
<b>Drift</b>	< 0.25% / h	< 0.25% / h
<b>Optical Power in 600 μm fiber</b>	0.2 μWatt	7 μWatt
<b>Lamp Lifetime</b>	1000 hours	2000 hours
<b>Temp. Range</b>	5°C - 35°C	
<b>Power Supply</b>	12VDC / 450 mA	
<b>Dimensions, weight</b>	175 x 110 x 44 mm, 570 g	
<b>Lifetime shutter</b>	1.000.000 cycles (typical)	

## FULL PRODUCT SPECIFICATIONS

Want to know the full product specifications, gratings selection, resolution table, accessories options and ordering information? Click [here](#) or scan the QR code on the right



# AvaLight-DH-S Deuterium-Halogen Light Source

In need of more power than the AvaLight-DHc? The AvaLight-DH-S is Avantes' most powerful deuterium halogen source. Like the DHc, it is also a combined deuterium and halogen light source, capable of transmitting light in the UV/VIS/NIR range, but has 35 times more halogen output and up to 300 times more deuterium power. The source has a prominent 656 nm deuterium peak which can limit dynamic range (see Avalight-DH-S-BAL as an alternative). It includes a focusing lens assembly to fully utilize the possibilities and size of your fiber.



The AvaLight-D-S is a deuterium light source only, making it an excellent option for measurements in the UV range of 190-400 nm. The AvaLight-D-S-DUV version starts even lower at 175 nm for your deep-UV experiments. This version also offers twice the intensity at 200nm.

The output of the AvaLight-DH-S is optimized for fibers or bundles up to 600 micrometers. The focal point is manually adjustable for larger fibers to optimize the light coupling into your fiber.

The AvaLight-D(H)-S features an integrated TTL shutter and filter holder for filters up to 50x50x5.0 mm.

## Technical Data

	Deuterium (Deep-UV) Long life	Deuterium (Standard) Long life	Halogen
<b>Wavelength Range</b>	175-400 nm	190-400 nm	360-2500 nm
<b>Warm-up Time</b>	30 min.		20 min.
<b>Lamp Power</b>	78W / 0.75A		5W /0.5A
<b>Lamp Lifetime</b>	2000 h		1000 h
<b>Noise (AU)</b>	2x 10 <sup>-5</sup>		10 <sup>-4</sup>
<b>Max. drift</b>	± 0.5%/h		±0.1%/h
<b>Color Temperature</b>	-	-	3000 K
<b>Optical Power* in 200µm fiber</b>	11 µW	11 µW	43 µW
<b>Optical Power* in 600µm fiber</b>	72 µW	72 µW	239 µW
<b>Optical Power* in 1000µm fiber</b>	206 µW	206 µW	354 µW
<b>Power consumption</b>	90 Watt (190Watt for heating D-Lamp 4-5 sec.)		
<b>Power Requirements</b>	100-240VAC 50/60 Hz		
<b>Dimensions / Weight</b>	315 x 165 x 140 mm / ca 5 kg.		
<b>Lifetime shutter</b>	1,000,000 cycles (typical)		

\* total power for the specified wavelength range

For a table of separate 50x50 mm filters to install in AvaLight-D(H)-S see AvaLight-HAL.

## FULL PRODUCT SPECIFICATIONS

Want to know the full product specifications, gratings selection, resolution table, accessories options and ordering information?  
Click [here](#) or scan the QR code on the right



# AvaLight-DH-S-BAL Balanced Power

The AvaLight-DH-S is a powerful deuterium halogen source, but like any unbalanced deuterium halogen source, it does have a very dominant alpha peak at 656 nm. This is why Avantes developed the DH-S-BAL, in which a dichroic filter drastically reduces this peak. This means less power but an increase in the dynamic range of a factor of 20.

The light source delivers a continuous spectrum with high efficiency. The most increased stability is in the ultraviolet, visible, and near-infrared range, from 215 to 2500 nm. An integrated TTL-shutter and filter holder for filters up to 50x50x5.0 mm are included. The TTL-shutter can be controlled from any AvaSpec spectrometer, which means the auto-save dark option in AvaSoft software can be used (please note: IC-DB26-2 cable needed).

The fiber is connected through an SMA-905 connector, which features an adjustable focusing lens assembly. This ensures you get the maximum possible power into your fiber. For all deuterium light sources, solarization-resistant fibers are recommended. The output of the AvaLight-DH-S-BAL is optimized for fibers or bundles up to 600 µm.

The filter holder can be easily replaced by a direct-attach cuvette holder CUV-DA-DHS (see section accessories), useful for fluorescence or absorbance measurements.

## Benefits of the AvaLight-DH-S-BAL

- Balanced light source
- Wide spectrum: 215-2500 nm
- Integrated TTL-shutter
- High efficiency
- Increased dynamic range



## Technical Data

	Balanced Deuterium (Standard)	Balanced Halogen Lamp
<b>Wavelength Range</b>	215-500 nm	500-2500 nm
<b>Warm-up Time</b>	30 min.	20 min.
<b>Lamp Power</b>	78 W / 0.75 A	5 W / 0.5 A
<b>Lamp Lifetime</b>	2000 hrs	1000 hrs
<b>Noise (AU)</b>	2x 10 <sup>-5</sup>	10 <sup>-4</sup>
<b>Max. drift</b>	± 0.5%/hr	±0.1%/hr
<b>Color Temperature</b>	-	3000 K
<b>Optical Power in 200 µm fiber</b>	6 µW	17 µW
<b>Optical Power in 600 µm fiber</b>	33 µW	160 µW
<b>Optical Power in 1000 µm fiber</b>	90 µW	448 µW
<b>Power consumption</b>	90 Watt (190 Watt for heating D-Lamp 4-5 sec.)	
<b>Power Requirements</b>	100-240VAC 50/60 Hz	
<b>Dimensions / Weight</b>	315 x 165 x 140 mm / ca 5 kg.	
<b>Lifetime shutter</b>	1,000,000 cycles (typical)	

For a table of separate 50x50 mm filters to install in AvaLight-D(H)-S see AvaLight-HAL.

## FULL PRODUCT SPECIFICATIONS

Want to know the full product specifications, gratings selection, resolution table, accessories options and ordering information? Click [here](#) or scan the QR code on the right



# AvaLight-XE Pulsed Xenon

The AvaLight-XE is a pulsed xenon light source perfect for ultraviolet applications like fluorescence. When connected to your AvaSpec spectrometer through the IC-DB26-2 cable (sold separately), the flashes are synchronized with the data collected by the spectrometer. You can select the number of flashes per scan in our software, AvaSoft.

With a special DUV bulb, the AvaLight-XE can be used for deep ultraviolet application (below 200 nm). A special direct-attach cuvette holder is available for your fluorescence with the CUV-ATT-DA, which has an iris attenuator to limit the light output and avoid saturation.



## Benefits of the AvaLight-XE

- Pulsed light source
- Perfect for fluorescence
- Cuvette holder available
- Long lifetime

## Technical Data

<b>Spectral Output</b>	200 nm to 1000 nm
<b>Total Optical Power output</b>	39 $\mu$ J per pulse (average 66 mW)
<b>Optical Power in 200 <math>\mu</math>m fiber</b>	0.66 $\mu$ J per pulse (average 20 $\mu$ W)
<b>Optical Power in 600 <math>\mu</math>m fiber</b>	3.2 $\mu$ J per pulse (average 320 $\mu$ W)
<b>Optical Power in 1000 <math>\mu</math>m fiber</b>	7.4 $\mu$ J per pulse (average 744 $\mu$ W)
<b>Synchronization Input</b>	15 pin sub-D connector, TTL level
<b>Pulse Duration</b>	5 $\mu$ s (at 1/3 height)
<b>Pulse delay</b>	6 $\mu$ s
<b>Pulse rate (max.)</b>	100 Hz
<b>Bulb Life</b>	min. 10 <sup>9</sup> pulses
<b>Connector</b>	SMA-905 connector
<b>Power requirement</b>	12 VDC/550 mA
<b>Dimensions, weight</b>	175 x 110 x 44 mm, 540 grams

## FULL PRODUCT SPECIFICATIONS

Want to know the full product specifications, gratings selection, resolution table, accessories options and ordering information? Click [here](#) or scan the QR code on the right





# AvaLight-XE-HP High Power Pulsed Xenon

The AvaLight-XE-HP is a pulsed xenon light source perfect for ultraviolet applications like fluorescence. When connected to your AvaSpec spectrometer through the Y-cable, the flashes are synchronized with the data collected by the spectrometer. You can select the number of flashes per scan in our software, AvaSoft.

Compared to the Avalight-XE (2W), the XE-HP can provide significantly more power. The AvaLight-XE-HP comes in compact housing and is ideal for OEM integration.



## Technical Data

<b>Spectral Output</b>	200 nm to 1000 nm
<b>Total Optical Power output</b>	max 6W / 39mJ per flash
<b>Synchronization Input</b>	9 pin sub-D connector, TTL level
<b>Pulse rate (max.)</b>	150 Hz
<b>Long Life</b>	1,0 x 10 <sup>9</sup> flashes
<b>Connector</b>	SMA-905 connector
<b>Power requirement</b>	11 -28 VDC/2.08A
<b>Dimensions, weight</b>	98 x 44 x 35 mm, 192 grams

## FULL PRODUCT SPECIFICATIONS

Want to know the full product specifications, gratings selection, resolution table, accessories options and ordering information? Click **here** or scan the QR code on the right



# AvaLight-HPLED Light Sources for Fluorescence

The AvaLight-HPLED is a compact, affordable LED light source for fluorescence applications. This high-power version is designed for more demanding applications than our regular LED light source.

The AvaLight-HPLED light sources produce continuous or pulsed spectral output at different wavelengths. All sources have an SMA-905 connector to connect fiber optics and come with a 5V/1.6A power supply.

This high-power LED light source can be used as a DC source or pulsed with a programmable Pulse Width Modulation (PWM) supplied by an AvaSpec-USB2 or EVO spectrometer (IC-DB26-2 cable needed).

## AvaLight-HPLED



### Benefits of the AvaLight-HPLED:

- Compact
- High power levels
- Fluorescence excitation
- Several excitation wavelengths

### Technical Data for AvaLight-HPLED

	AvaLight-HPLED-285	AvaLight-HPLED-385	AvaLight-HPLED-405	AvaLight-HPLED-470	AvaLight-HPLED-530	AvaLight-HPLED-625	AvaLight-HPLED-White
<b>Peak wavelength</b>	282 nm	385 nm	405 nm	470 nm	530 nm	625 nm	N.A.
<b>FWHM (nm)</b>	15 nm	15 nm	15 nm	25 nm	35 nm	25 nm	N.A.
<b>Optical power 600 µm fiber</b>	0,5 mWatt	3.4 mWatt					
<b>Connector</b>	SMA-905						
<b>Power supply</b>	5V, 500 mA						
<b>Dimensions, weight</b>	150 x 78 x 37 mm, 420 grams						

## FULL PRODUCT SPECIFICATIONS

Want to know the full product specifications, gratings selection, resolution table, accessories options and ordering information? Click **here** or scan the QR code on the right



# AvaLight-HAL-CAL-Mini and AvaLight-DH-CAL Calibrated Light Sources

Calibrating your spectrometer has never been easier: the AvaLight-HAL-CAL-Mini and AvaLight-DH-CAL are NIST traceable calibrated light sources that measure absolute spectral intensity.

The AvaLight-HAL-CAL-Mini is a compact, affordable light source. It is calibrated for the visible range (350-1095 nm). Optionally, you can order an extended calibration for the near-infrared spectral range (1100-2500 nm). It has a built-in diffuser, a cosine corrector with an SMA adapter, and comes with a calibration file in ASCII format. Calibration can be done using the AvaSoft software.

The AvaLight-HAL-CAL-ISPxx-Mini is a special version of the AvaLight-HAL-CAL-Mini, which enables coupling any of Avantes' AvaSphere-xx-IRRAD integrating spheres to the light source (xx=30, 50 or 80) for calibration. This source is supplied with a special bottom plate to stabilize the AvaSphere. The AvaLight-HAL-CAL-Mini and AvaLight-HAL-CAL-ISPxx-Mini include a power supply.

## Benefits of the AvaLight-HAL-CAL-Mini

- Field calibration
- Visible and optional NIR range
- Built-in diffuser
- Versatile

For calibrations in the ultraviolet and visible range (200-1099 nm), the AvaLight-DH-CAL is the best solution. This source can be used with all AvaSpec spectrometers to calibrate for absolute spectral intensity. It is supplied with a built-in diffuser, a cosine corrector (CC-VIS/NIR) with an SMA adapter and the calibration files in ASCII format.

Two calibration files are included: one for irradiance calibration over the full range (200-1099 nm) and one over the visible and near-infrared range (350-1099 nm). For the first file, both the deuterium and the halogen bulb should be used during calibration. The second file is to be used with only the halogen light. The halogen-only spectrum provides a smoother black body calibration spectrum for the longer wavelengths.

For a more balanced spectrum across the 200-1100 nm range, Avantes offers the AvaLight-DH-BAL-CAL. For ultraviolet range calibration only (200-400 nm), the AvaLight-D-CAL is the right choice.

The calibration files can be imported into the AvaSoft-IRRAD application software for intensity calibration, which turns your spectrometer into a spectroradiometer.

The AvaLight-DH-CAL-ISPxx is a special version of these calibrated light sources, meant to facilitate coupling of the AvaSphere-xx-IRRAD integrating spheres to the light source (xx is 30, 50, or 80).

## Benefits of the AvaLight-DH-CAL

- Flexible calibration
- Ultraviolet and visible range
- Built-in diffuser and cosine corrector

## AvaLight-HAL-CAL-Mini



## AvaLight-DH-CAL



# AvaLight-HAL-CAL-Mini and AvaLight-DH-CAL Calibrated Light Sources

## Technical Data

	AvaLight-HAL-CAL-Mini	AvaLight-DH-(BAL)-CAL
<b>Calibration use</b>	Irradiance $\mu\text{W cm}^{-2} \text{ nm}^{-1}$	Irradiance $\mu\text{W cm}^{-2} \text{ nm}^{-1}$
<b>Calibrated surface</b>	CC-VIS/NIR or AvaSphere	CC-VIS/NIR or AvaSphere
<b>Wavelength Range</b>	350-1095 nm / 1100-2500 nm*	200-1099 nm
<b>Calibration Repeatability</b>	$\pm 0.5 \%$	$\pm 1.0\%$
<b>Calibration Relative Uncertainty to NIST standard</b>	$\pm 5.0\%$ (350-1100 nm) $\pm 3.5\%$ (1100-1950 nm) $\pm 5.0\%$ (1950-2500 nm)	$\pm 10\%$ (200-240 nm) $\pm 9\%$ (240-350 nm) $\pm 10\%$ (350-400 nm) $\pm 9.5\%$ (400-1100 nm)
<b>Calibration valid for</b>	60 hrs	60 hrs
<b>Warm-up Time</b>	Ca. 15 min.	Ca. 30 min.
<b>Bulb Output</b>	$170\mu\text{W cm}^{-2} \text{ nm}^{-1}$ (@800 nm)	$80 \mu\text{W cm}^{-2} \text{ nm}^{-1}$ (@215 nm) $5 \mu\text{W cm}^{-2} \text{ nm}^{-1}$ (@800 nm)
<b>Power requirement</b>	12 V / 2.08A	100-240 VAC
<b>Dimensions</b>	150 x 78 x 37 mm	315 x 165 x 140 mm

\* optional extended range NIR calibration

## FULL PRODUCT SPECIFICATIONS

Want to know the full product specifications, gratings selection, resolution table, accessories options and ordering information?  
Click [here](#) or scan the QR code on the right



# AvaLight-CAL Spectral Calibration Source

The AvaLight-CAL-xxx is a spectral calibration lamp. It's available in Mercury-Argon (253.6-922.5 nm), Neon (337-1084.5 nm), Argon (696.5-1704 nm), Zinc (202.5-636.2 nm), and Cadmium (214.4-643.8 nm) versions. The major lines, including their relative intensity and structures, are shown below.

The standard SMA-905 connector supplies an easy connection between the lamp and optical fibers, making the AvaLight-CAL-xxx a low-cost wavelength calibration system for any fiber-optic spectrometer. AvaSoft-Full software includes an automatic recalibration procedure.

The AvaLight-CAL-Mini, AvaLight-CAL-AR-Mini, and AvaLight-CAL-Neon-Mini all come in the Mini-housing. They are equipped with a connector at the rear, enabling them to switch the unit on/off remotely with a TTL signal.

The AvaLight-CAL can also be delivered in a rack-mountable version to be integrated into Avantes 19" Rack-mount or the 9.5" desktop housing. The PS-12V/2.08A power supply should be ordered separately.

## Benefits of the AvaLight-CAL

- Calibration light source
- Available in a variety of wavelength ranges (UV to NIR)

AvaLight-CAL-Mini



## Technical Data

Lamp	HgAr	Neon	Ar	Zinc	Cadmium
<b>Output</b>	253.6–922.5 nm	337–966 nm	950–1704 nm	202.5–636.2 nm	214.4–643.8 nm
<b>Optical power in 600 μm fiber</b>	1.6 μW				
<b>Connector</b>	SMA-905 connector				
<b>Internal Voltage</b>	1200 Volts AC at 30 kHz, 10 mA			1500 Volts AC at 27 kHz, 47.5 mA	
<b>Warm up</b>	1 minute for vapor stabilization			< 10 min.	
<b>Lamp lifetime</b>	5000 hrs.			1000 hrs.	
<b>Power requirement</b>	12VDC supply, 240 mA			85–240 VAC, 1.0A	
<b>Dimensions, weight</b>	150 x 78 x 37 mm, 480 grams			Lamp unit : 175 x 110 x 44 mm, 480 grams Power supply unit : 102 x 167 x 58 mm, 450 grams	

## FULL PRODUCT SPECIFICATIONS

Want to know the full product specifications, gratings selection, resolution table, accessories options and ordering information? Click [here](#) or scan the QR code on the right



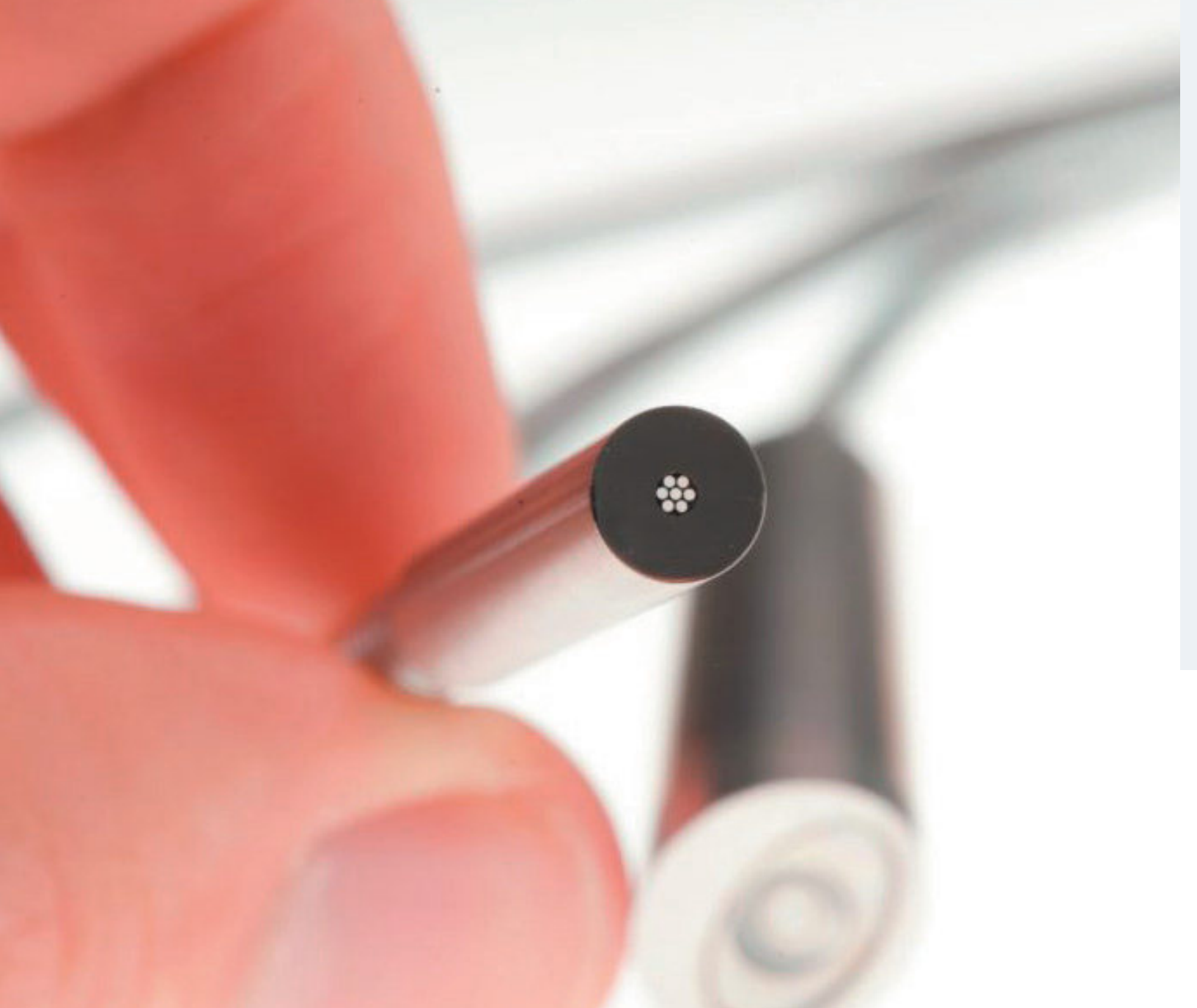

# FIBER OPTICS

## INTRODUCTION

Using fiber optics as light guidance allows great modularity and flexibility in the setup of an optical measurement system. Optical fibers can be made of many materials, such as plastic, glass, and silicates ( $\text{SiO}_2$ ). For high-quality fiber optics, as used in spectroscopic applications, synthetic fused silica (amorphous silicon dioxide) is used. This can be intentionally doped with trace elements to adjust the optical properties of the glass.

Total internal reflection is the basic principle of light transport through an optical fiber. This means that the light within the numerical aperture of a fiber ( $\text{NA} = \text{input acceptance cone}$ ) will be reflected and transported through the fiber. The size of the numerical aperture depends on the materials used for core and cladding.

# ABOUT OUR FIBERS

IN-HOUSE  
PRODUCTION  
OF FIBER  
OPTICS

One can identify two basic types of silica fibers: single-mode and multi-mode fibers, depending on the propagation state of the light traveling down the fiber. For most spectroscopic applications, multi-mode fibers are used. Multi-mode fibers can be divided into two subcategories: step-index and graded-index. A relatively large core and high NA allow light to be easily coupled into the fiber, which enables the use of relatively inexpensive termination techniques. Step-index fibers are mainly used in spectroscopic applications.

We offer various jacketing materials for different applications. Standard fiber-optic cables and bifurcated cables are protected by Kevlar-reinforced polypropylene inner tubing with PVC red outer jackets. All of our standard reflection probes are protected by a flexible stainless steel jacket, with an interlocking profile (BX) or a chrome-plated brass outer jacket, with a hooked profile (ME) for optimum strain relief with silicon or PTFE inner tubing. For waterproofing and some medical applications, stainless-steel spiral jacketing with Glassilk and grey outer silicon rubber coating can be provided. Inside this jacket, silicon or PTFE inner tubing is used as well. For heavy industrial environments, we advise the use of metal stainless steel (-BX) jacketing.

## MORE INFORMATION



Find detailed information about our fiber optics on our website. Click [here](#) or scan the QR code to read all about fiber optic design, connectors, properties, and more

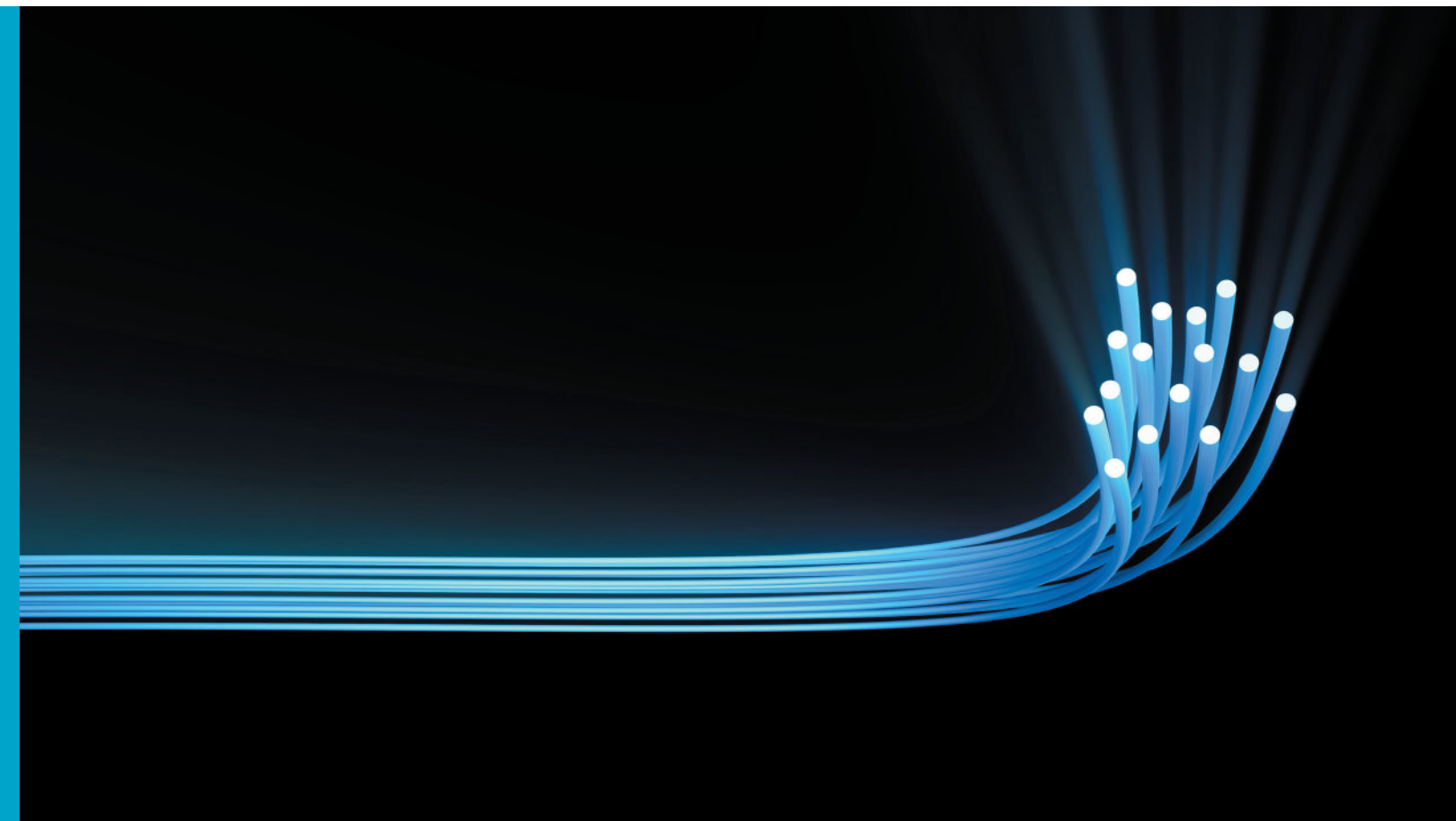

# Fiber Optic Probe Properties

Avantes offers a broad standardized product range of fiber optics as described in this catalog. For special cases, Avantes modifies these fiber optic cables and probes to customers' requests. Most materials in our fiber optic assemblies can be replaced with others to improve specific chemical or thermal resistance or enhance vacuum or pressure properties. Please get in touch with our fiber design engineers with your particular request.

In the following paragraphs, some of the essential technical parameters are listed for the materials we use.

## Thermal Resistance

The thermal resistance of a fiber-optic assembly depends on some of the materials used:

1. Fiber: the standard fiber design has a polyimide buffer, covering a wide thermal range  $-190$  to  $400$  °C.
2. Jacketing: the standard jacketing is PVC-based and has a small temperature range ( $-20$ °C to  $65$ °C). For higher temperatures, a flexible metal jacketing (-BX/ME) with silicone inner tubing (up to  $250$ °C) or stainless steel tubing (not flexible, to  $750$ °C) is recommended.
3. Probe ends: connectors and ferrules are standard made of metal and have a wide temperature range. A limited temperature range is applicable for special plastics like PVC, PEEK, and Teflon.
4. Bonding epoxy: the standard epoxy used is a heat-curing bonding epoxy with a temperature range of  $-60$ °C to  $175$ °C. The curing temperature is standard  $100$  °C. For high-temperature ranges (order code -HT), the curing temperature is  $200$ °C. For the HTX (extremely high temperature), fibers and probes ceramic solution are available to realize a process that can withstand temperatures up to  $500$ °C.

## Technical Data

Temperature range	Fiber	Jacketing	Probe end	Bonding
$-20$ °C to $+65$ °C	Standard Polyimide	Standard PVC	Standard metal/ PVC/PEEK	Standard Epoxy
$-30$ °C to $+100$ °C	Standard Polyimide	Metal (-BX/ME) or silicone (-MS)	Standard metal/ PEEK	Standard Epoxy
$-60$ °C to $+200$ °C (HT)	Standard Polyimide	Metal (-BX/ME) or silicone (-MS)	Standard metal/ PEEK	High temperature curing epoxy



# Fiber Optic Cables

Avantes offers a wide range of fiber-optic cables, which can be made in various lengths and configurations to meet your needs. For common applications, a 2-meter length is sufficient. For this reason, it is our standard fiber length.

Avantes offers SMA-905 or FC/PC connectors, which can be the same or different on both ends. For some applications, special round-to-linear fiber cables are recommended. A bundle of fibers is configured in a round pattern on one end and a linear array on the other. The linear array (typically 1 mm in height) is aligned with the slit height of the spectrometer, which is also 1 mm. This fiber configuration provides maximized light throughput for applications requiring high sensitivity.

Fiber optic cable types and diameters are recommended based on the wavelength range and the sensitivity required for a measurement. In general, different fiber types can be classified. For the UV range, high OH UV/VIS fiber is used. For customers working below 240 nm in the UV, a special high OH UV/VIS fiber called solarization resistant fiber (SR) is available. For longer wavelengths, low OH VIS/NIR fiber is recommended.

The best of both worlds can be achieved with our broadband (solarization-resistant) fiber, which is our standard. This gives you the combined performance of the UV, UV-SR, and IR fibers.

Avantes also offers a variety of jacketing options, including Kevlar-reinforced PVC sleeving with PTFE inner tubing (standard), chrome-plated brass mono coil, stainless steel BX, silicone-coated stainless steel mono coil, and other special jacketing upon request. Special high-temperature epoxy (HT) is available for applications requiring high-temperature resistance and should be specified at the time of order.

Recommended wavelengths for different cables:

200-2500 nm: UV/VIS/NIR (UVIR)

UV/IR is available in core sizes 100, 200, 400, and 600  $\mu\text{m}$

200-800 nm: Solarization resistant (-SR)

250-800 nm: UV/VIS (UV)

350-2500 nm: VIS/NIR (IR)

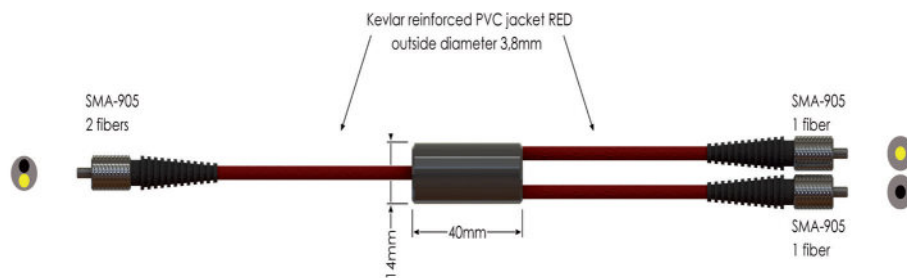

## FULL PRODUCT SPECIFICATIONS

Want to know the full product specifications, gratings selection, resolution table, accessories options and ordering information? Click [here](#) or scan the QR code on the right



# Multi-Furcated Fiber Optic Cables

Simultaneous multi-point measurements and Avantes multi-channel spectrometers require multi-furcated fiber optic cables. These assemblies can function as a combiner or splitter of light as they have multiple legs on one side, which converge into a single connector on the opposite side. Avantes offers virtually any combination possible, which can be adapted to your requirements.

## Typical setups that require multi-furcated cables are:

- One sampling point, such as an integrating sphere, cosine corrector, or collimating lens, is measured with several spectrometers (individual AvaSpecs or Multi-channel).
- Multiple illumination fibers split out from one light source to different sampling points.

Various types of connectors, jacketing, and fiber sizes are available for these multi-furcated fiber cables. Contact us to configure and quote you on your specific needs.

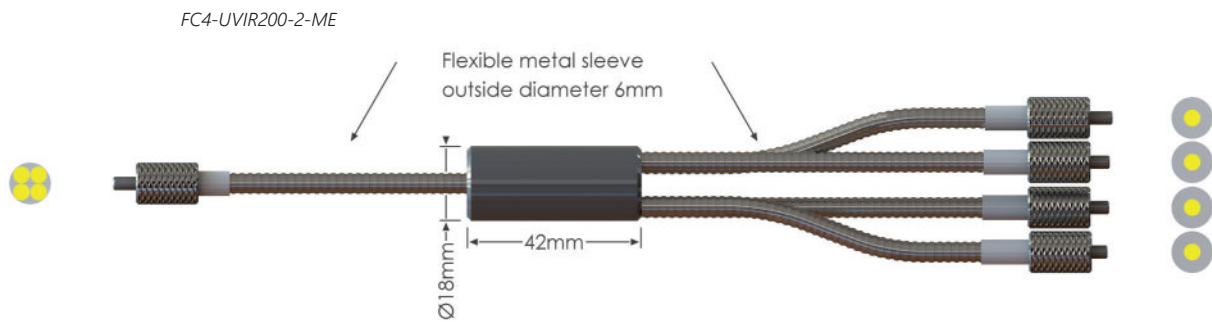
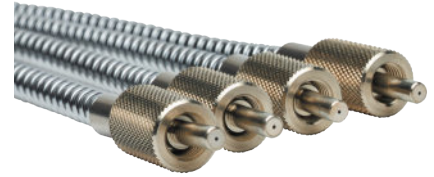

## FULL PRODUCT SPECIFICATIONS

Want to know the full product specifications, gratings selection, resolution table, accessories options and ordering information? Click [here](#) or scan the QR code on the right



# Reflection Probes (Standard)

Reflection probes are used to obtain spectral information of diffuse or specular materials. The light from a light source is sent through six illumination fibers to the sample, and the reflection is measured by a 7th fiber in the center of the reflection probe tip. The 7th fiber is coupled to a spectrometer configured to the appropriate wavelength range of interest. More illumination fibers can be added to get more energy from the light source, increasing the reflection signal level.

For measurements under an angle of 90°, the FCR-90-Option was developed. It's a special adapter with a mirror positioned at 45° and can be easily mounted on the tip of Avantes standard reflection probes.

The FCR-COL is an adjustable UV/VIS/NIR collimating and focusing lens, which enables focusing the measurement spot at an extended distance.



## Technical Data

<b>Fibers</b>	7 fibers 200 μm or 400 μm core, 6 light-fibers, 1 read fiber, N.A.= 0.22. Standard 2 m length, splitting point in the middle.
<b>Wavelength range</b>	200-2500 nm (UV/VIS/NIR)
<b>Connectors</b>	SMA-905 connectors (2x)
<b>Probe end</b>	Stainless steel 316 cylinder, 50 mm long x 6.35 mm diameter. Optionally -PK for PEEK or -HY for Hastelloy® C276 (on request)
<b>Jacketing</b>	The optical fibers are protected by a silicon inner tube and a flexible stainless steel (BX, O.D. 6.0 mm) or chrome plated brass (ME, O.D. 5.0 mm) outer jacket. The jacketing also gives stress relieve.
<b>Temperature</b>	-30°C to 100°C. (-HT version 200 °C)
<b>Pressure</b>	Probe head 50 bar @ 25 °C
<b>Bending</b>	Minimum bend radius: Short term (few seconds) 20-40 mm, long term: 120 -240 mm

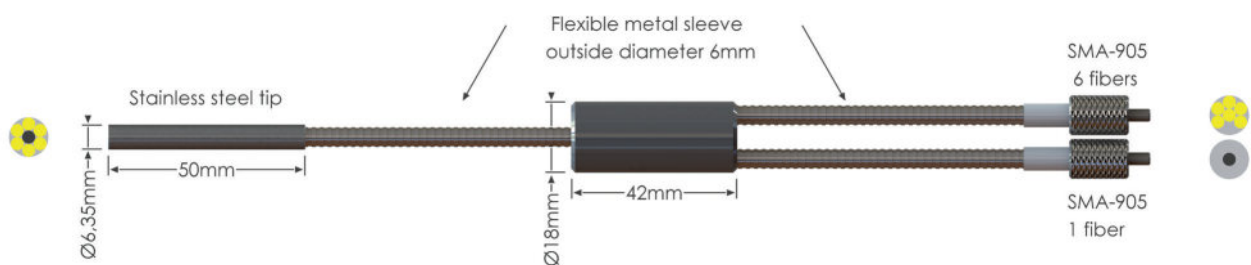

## FULL PRODUCT SPECIFICATIONS

Want to know the full product specifications, gratings selection, resolution table, accessories options and ordering information? Click [here](#) or scan the QR code on the right



# Reflection Probes with Multiple Legs

For some measurements, a reflection probe is needed that can be coupled to two spectrometers and a light source. A good example is a reflection measurement in the UV/VIS and NIR range. For these situations, Avantes offers our reflection probes with multiple legs.

The light from a light source is coupled into a fiber bundle consisting of 17 illumination fibers that transport the light to the end of the probe. The light is uniformly reflected into the two read fibers, each connected to a spectrometer.



For measurements under a 90° angle, the FCR-90-Option has been developed. It is an adapter with a mirror mounted at 45° and can be easily mounted to the tip of these reflection probes.

The FCR-COL adjustable US/VIS/NIR collimating/focusing lens is available and can be mounted to the tip of these probes to accurately focus a small measurement spot from a higher distance.

## Technical Data

<b>Fibers</b>	19 fibers 200 µm core, 17 light-fibers, 2 read fibers in 2 separate legs, N.A.= 0.22. Standard 2 m length, splitting point in the middle.
<b>Wavelength range</b>	200-2500 nm (UV/VIS/NIR)
<b>Connectors</b>	SMA-905 connectors (3x)
<b>Probe end</b>	Stainless steel 316 cylinder, 50 mm long x 6.35 mm diameter. Optionally -PK for PEEK or -HY for Hastelloy® C276 (on request)
<b>Jacketing</b>	The optical fibers are protected by a silicon inner tube and a flexible stainless steel (BX, O.D. 6.0 mm) or chrome plated brass (ME, 5.0 mm) outer jacket. The jacketing also gives stress relieve.
<b>Temperature</b>	-30°C to 100°C. (-HT version 200°C)
<b>Pressure</b>	Probe head 50 bar @ 25°C
<b>Bending</b>	Minimum bend radius: Short term (few seconds) 20 mm, long term: 120 mm

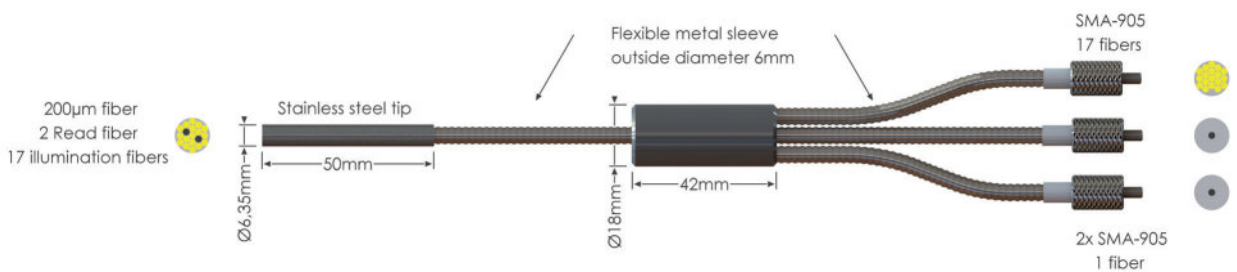

## FULL PRODUCT SPECIFICATIONS

Want to know the full product specifications, gratings selection, resolution table, accessories options and ordering information? Click [here](#) or scan the QR code on the right



# Reflection Probes with Reference

In order to correct fluctuations and drift from your light source, periodic referencing is required. Avantes offers this series of reflection probes with a self-referencing feature to facilitate this. The light coming from the light source is bundled into 12 fibers, which are split into two 6-fiber bundles.

One of these bundles is carried to the probe end for sample measurements, and the other bundle of 6 is directed to a white reflection tile built into the probe to provide a light source reference. This reference leg is connected to a slave spectrometer channel dedicated to light source referencing or may be routed to a single channel via a fiber optic (contact a Sales Engineer about this special configuration).

On the measurement side, the probe end has a 7th fiber which reflects light to the master spectrometer channel.



## Technical Data

<b>Fibers</b>	14 fibers 200 $\mu\text{m}$ core, 12 light-fibers, 2 x 1 read fiber, N.A.= 0.22. Standard 2 m length, splitting point in the middle.
<b>Wavelength range</b>	200-2500 nm (UV/VIS/NIR)
<b>Connectors</b>	SMA-905 connectors (3x)
<b>Probe end</b>	Stainless steel 316 cylinder, 50 mm long x 6.35 mm diameter . Optionally –PK for PEEK or –HY for Hastelloy® C276 (on request).
<b>Jacketing</b>	The optical fibers are protected by a silicon inner tube and a flexible stainless steel (BX, O.D. 6.0 mm) or chrome plated brass (ME, 5.0 mm) outer jacket. The jacketing also gives stress relieve.
<b>Temperature</b>	-30°C to 100°C. (-HT version 200°C)
<b>Pressure</b>	Probe head 50 bar @ 25°C
<b>Bending</b>	Minimum bend radius: Short term (few seconds) 20 mm, long term: 120 mm

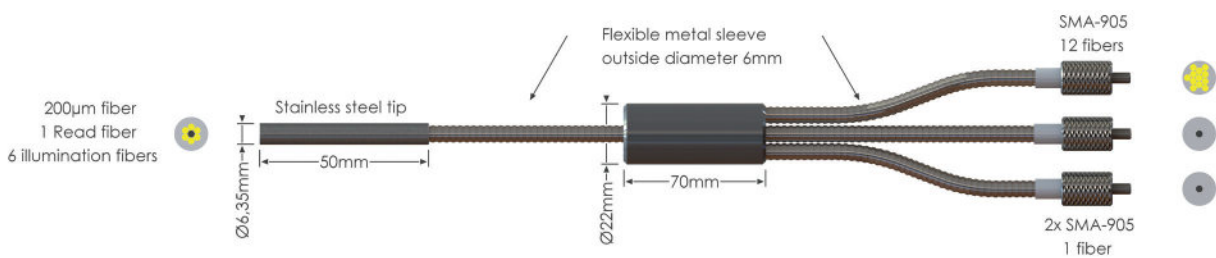

## FULL PRODUCT SPECIFICATIONS

Want to know the full product specifications, gratings selection, resolution table, accessories options and ordering information? Click [here](#) or scan the QR code on the right



# Reflection Probes with Small Tips

For some medical and semiconductor applications, a (very) small tip is desired to do reflectance measurements. Avantes offers two standard diameters of small tip reflection probes, 1.5 and 2.5 mm, and each tip usually is 100 mm long.

The probe is configured with an illumination leg with six 200  $\mu\text{m}$  fiber cables that connect to a fiber-coupled light source and a single 200  $\mu\text{m}$  read fiber cable to measure the reflection via connection to a spectrometer.

A special angled fiber holder (AFH-15) is available for the 1.5 mm diameter reflection probe. This device enables reflection measurements under angles of 15, 30, 45, 60, 75 and 90 degrees. For more information, see 'Reflection probe holders'.



## Technical Data

<b>Fibers</b>	7 fibers 200 $\mu\text{m}$ core, 6 light-fibers, 1 read fiber, N.A. = 0,22. Standard 2 m length, splitting point in the middle.
<b>Wavelength range</b>	200-2500 nm (UV/VIS/NIR)
<b>Connectors</b>	SMA-905 connectors (2x)
<b>Probe end</b>	Stainless steel cylinder, 100 mm long x 1.5 or 2.5 mm diameter.
<b>Jacketing</b>	The optical fibers are protected by a Kevlar reinforced PTFE jacket with PVC sleeving. OD: 3.8 mm
<b>Temperature</b>	-20°C to 65°C
<b>Bending</b>	Minimum bend radius: Short term (few seconds) 20 mm, long term: 120 mm

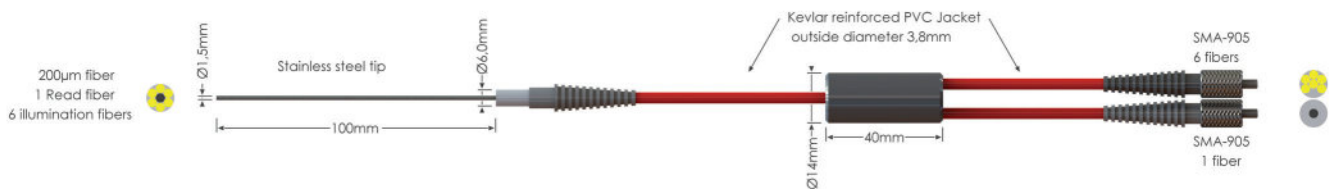

## FULL PRODUCT SPECIFICATIONS

Want to know the full product specifications, gratings selection, resolution table, accessories options and ordering information? Click [here](#) or scan the QR code on the right



# Reflection Probes for Powders and Thick Fluids

Avantes offers this specially designed series of reflection probes to effectively measure reflection in powders and thick fluids. The probes allow the user to dip the probe into the powder or thick fluids to measure.

The illumination leg of the probe is connected to a light source and carries light to the sample via a bundle of six fibers. At the probe tip, a 45-degree fused silica window illuminates the sample and collects the indirect reflections carried by a single fiber to the spectrometer. The 45-degree angle of the probe prevents the measurements of direct back reflection from the window, thus improving the dynamic range of your measurement.



## Technical Data

<b>Fibers</b>	7 fibers 200 $\mu\text{m}$ core, 6 light-fibers, 1 read fiber, N.A. = 0.22. Standard 2 meter length
<b>Wavelength range</b>	200-2500 nm (UV/VIS/NIR)
<b>Connectors</b>	SMA-905 connectors (2x)
<b>Probe end</b>	Stainless steel 316 cylinder, 140 mm long x 6.0 mm diameter. The probe end contains a 5 mm diam. x 1 mm thick fused silica window. Waterproof. Optionally -PK for PEEK or -HY for Hastelloy® C276 (on request).
<b>Jacketing</b>	The optical fibers are protected by a silicon inner tube and a flexible stainless steel (BX, O.D. 6.0 mm) or chrome plated brass (ME, O.D. 5.0 mm) outer jacket. The jacketing also gives stress relieve.
<b>Temperature</b>	-30°C to 100°C. (-HT version 200°C)
<b>Pressure</b>	Probe head 10 bar @ 25°C
<b>Bending</b>	Minimum bend radius: Short term (few seconds) 20 mm, long term: 120 mm

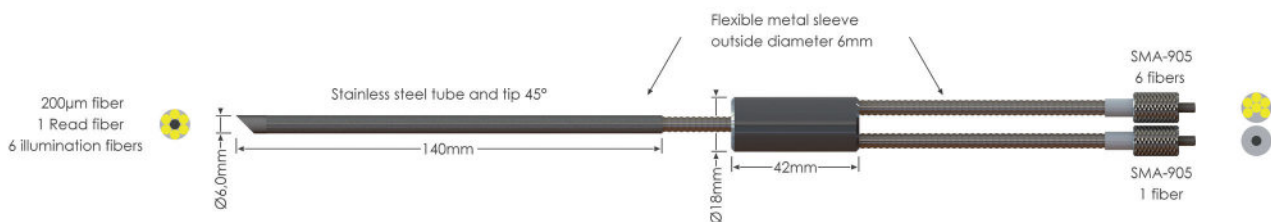

## FULL PRODUCT SPECIFICATIONS

Want to know the full product specifications, gratings selection, resolution table, accessories options and ordering information? Click [here](#) or scan the QR code on the right



# 1/2" Industrial Reflection Probes for Powders and Thick Fluids

For industrial applications that need reflection measured in thick liquids or powders, this probe is the ideal choice. The stainless steel cylinder and probe end make it withstand extreme situations. The tip is exchangeable and waterproof. Optionally, PEEK or Hastelloy® C276 can be used as tip material.

The light enters from the light source through six bundled fibers to the probe end, where it lights the material to be analyzed through a sapphire window angled at 45 degrees. This angle prevents any light from being reflected from the window. The light is selectively reflected through the seventh fiber in the probe. This fiber leads to the connected spectrometer.



## Technical Data

<b>Fibers</b>	7 fibers 200 µm core, 6 light-fibers, 1 read fiber, N.A.= 0.22, standard 2 meter length
<b>Wavelength Range</b>	200-2500 nm (UV/VIS/NIR)
<b>Connectors</b>	SMA-905 connectors (2x)
<b>Probe End</b>	Stainless steel cylinder, 120 mm long x 12.7 mm (1/2") diameter. The probe end contains a ca. 10 mm diam. x 1 mm thick sapphire window. The probe tip is exchangeable and waterproof. Optionally –PK for PEEK or –HY for Hastelloy® C276
<b>Jacketing</b>	The optical fibers are protected by a silicon inner tube and a flexible stainless steel (BX, O.D. 6.0 mm) or chrome plated brass (ME, 5.0 mm) outer jacket. The jacketing also gives stress relieve.
<b>Temperature</b>	-40 °C to 100 °C. (-HT version 200°C)
<b>Pressure</b>	Probe head 10 bar @ 25°C
<b>Bending</b>	Minimum bend radius: Short term (few seconds) 20 mm, long term: 120 mm

## FULL PRODUCT SPECIFICATIONS

Want to know the full product specifications, gratings selection, resolution table, accessories options and ordering information? Click **here** or scan the QR code on the right





# 1/2" Industrial Fluorescence Probes

For effective measurement of fluorescence, Avantes offers this specially designed reflection probe. It features 12 excitation fibers of 200 μm around a 600 μm read fiber, which transports the fluorescence signal back to the spectrometer.

To turn the 45° reflection probe into a fluorescence probe, a special reflector accessory, FCR-FLTIP-IND, is attached to the probe end. It prevents ambient light from entering the probe and backscatters the excitation light. This increases the typically low fluorescence signal. The fluid channel path can be varied between 0 and 5 mm.

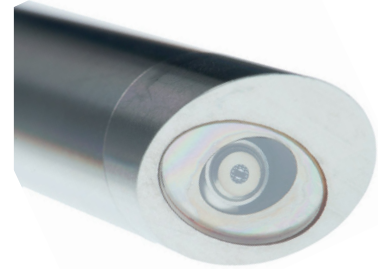

## Technical Data

<b>Fibers Illumination</b>	12 fibers of 200 μm, UV/VIS
<b>Fibers Detection</b>	1 fiber 600 μm
<b>Wavelength Range</b>	200-2500 nm (UV/VIS/NIR)
<b>Connector</b>	2 x SMA-905
<b>Probe End</b>	Stainless steel 316 cylinder, 128 mm long x 12,7 mm (1/2") diameter. The probe end contains a ca. 10 mm diameter x 1 mm thick sapphire window with anti-reflection coating. The probe tip is exchangeable and waterproof. Optionally -PK for PEEK or -HY for Hastelloy® C276
<b>Fluorescence Accessory</b>	See drawing below
<b>Jacketing</b>	The optical fibers are protected by a silicon inner tube and a flexible stainless steel (BX, O.D. 6.0 mm) or chrome plated brass (ME, 5.0 mm) outer jacket. The jacketing also gives stress relieve. Optionally a waterproof, steel reinforced, silicon jacket can be provided
<b>Temperature</b>	-30°C to 100°C. (-HT version 200°C)
<b>Pressure</b>	Probe head 10 bar @ 25°C
<b>Bending</b>	Minimum bend radius: Short term (few seconds) 60 mm, long term: 360 mm

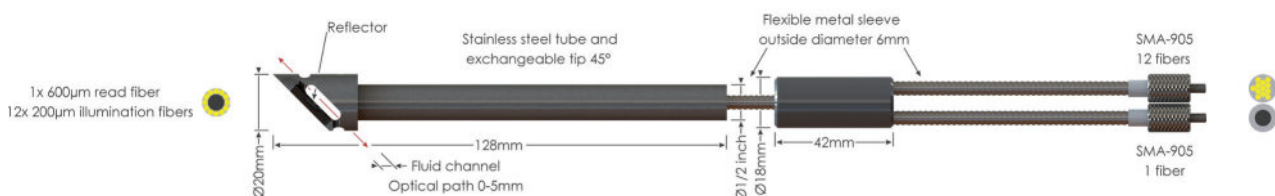

## FULL PRODUCT SPECIFICATIONS

Want to know the full product specifications, gratings selection, resolution table, accessories options and ordering information? Click [here](#) or scan the QR code on the right



# Mini Transmission Dip Probes

For absorption measurements in miniaturized centrifuge tubes or vessels, Avantes offers the mini transmission dip probe. Its miniaturized tip is 130 mm long and 3.2 mm in diameter.

The mini transmission dip probe has a fixed 5 or 10-mm optical path length. It is available in a UV/VIS/NIR (200-2500 nm) version. The probe features Avantes ME, chrome-plated brass jacketing.

Optionally the probe can be configured with a longer stainless steel or Hastelloy® tip and/or other jacketing options. The probe has two SMA connectors (FC/PC also available) for convenient coupling to the Avantes line of spectrometers and light sources.

Please get in touch with us for special requirements.



## Technical Data

<b>Fibers</b>	1 illumination and 1 detection fiber, both 200 μm, standard 2 meters length
<b>Wavelength Range</b>	200-2500 nm (UV/VIS/NIR)
<b>Connectors</b>	2 x SMA-905
<b>Probe End</b>	Stainless steel 316 cylinder, 130 mm long x 3.2 mm (1/8") diameter. The probe end contains 5 mm physical, 10 mm optical path, or a 2.5 mm physical gap (5 mm optical path). Optionally -HY for Hastelloy® C276
<b>Jacketing</b>	The optical fibers are protected by a silicon inner tube and a flexible stainless steel (optional BX, O.D. 6.0 mm) or chrome plated brass (standard ME, 5.0 mm) outer jacket. The jacketing also gives stress relieve.
<b>Temperature</b>	-40 °C to 100 °C. (-HT version 200°C)
<b>Pressure</b>	Probe head 10 bar @ 25°C
<b>Bending</b>	Minimum bend radius: Short term (few seconds) 20 mm, long term: 120 mm

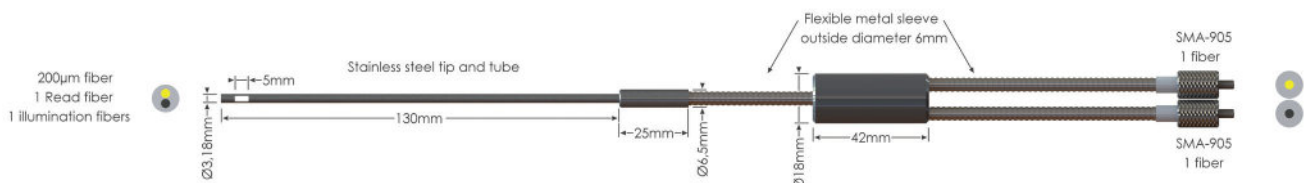

## FULL PRODUCT SPECIFICATIONS

Want to know the full product specifications, gratings selection, resolution table, accessories options and ordering information? Click [here](#) or scan the QR code on the right



# Transmission Dip Probes

Transmission dip probes are used for online and inline absorbance measurements in fluids. Absorbance can be measured when dipping or permanently mounting the probe end into the fluid.

A standard SMA-905 connector is used to couple light into a fiber bundle, typically consisting of six fibers (other configurations available upon request). The light is transmitted to the probe end, where it crosses the predetermined gap and is then reflected against a diffuse white reflective material back onto the receiving read fiber, which is coupled to a spectrometer on the second leg of the probe.



The read fiber is placed in the center of the illumination fiber bundle to provide the best collection efficiency for the probe. Both bundles are housed in flexible stainless steel jacketing, and the probe tip is also made of stainless steel. At the mid-point of the assembly, a ferrule is used to split the fibers into their respective legs (illumination and read), which are terminated in SMA-905 connectors.

## Technical Data

<b>Fibers</b>	6 illumination fibers, 1 detection fiber, all 200 μm, standard 2 meters
<b>Wavelength range</b>	200-2500 nm (UV/VIS/NIR)
<b>Connectors</b>	SMA-905 connectors (2x)
<b>Tips</b>	Replacement tips are available with 1, 2.5 and 5 mm spacing, i.e. an optical path of 2,5 and 10 mm and contain a 5 mm diam. x 1 mm thick fused silica window
<b>Probe end</b>	Stainless steel 316 cylinder, 100 mm long x 8,0 mm diameter. Waterproof.
<b>Jacketing</b>	The optical fibers are protected by a silicon inner tube and a flexible stainless steel (optional BX, O.D. 6.0 mm) or chrome plated brass (standard ME, 5.0 mm) outer jacket. The jacketing also gives stress relieve.
<b>Temperature</b>	-30°C to 100°C. (-HT version 200°C)
<b>Pressure</b>	Probe head 10 bar @ 25°C
<b>Bending</b>	Minimum bend radius: Short term (few seconds) 20 mm, long term: 120 mm

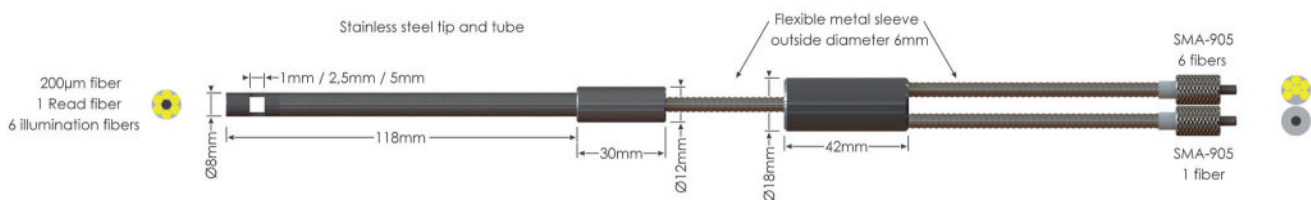

## FULL PRODUCT SPECIFICATIONS

Want to know the full product specifications, gratings selection, resolution table, accessories options and ordering information? Click [here](#) or scan the QR code on the right



# Transmission Dip Probes with Variable Path Length

This fiber-optic probe features a variable and adjustable path length for more flexibility during absorbance measurements in fluids. The gap between the fiber and the diffuser can be set anywhere between 0.25 and 10 mm.

A standard SMA-905 connector is used to couple light into a fiber bundle, typically consisting of six fibers (other configurations available upon request). The light is transmitted to the probe end, where it crosses the predetermined gap and is then reflected against a diffuse white reflective material back onto the receiving read fiber, which is coupled to a spectrometer on the second leg of the probe.

The read fiber is placed in the center of the illumination fiber bundle to provide the best collection efficiency for the probe. Both bundles are housed in flexible stainless steel jacketing, and the probe tip is also made of stainless steel. At the mid-point of the assembly, a ferrule is used to split the fibers into their respective legs (illumination or read), which are terminated in SMA-905 connectors.



## Technical Data

<b>Fibers</b>	6 illumination fibers, 1 detection fiber, all 200 $\mu$ m, standard 2 meters
<b>Wavelength range</b>	200-2500 nm (UV/VIS/NIR)
<b>Connectors</b>	SMA-905 connectors (2x)
<b>Optical Path</b>	0.25 - 10 mm physical gap, i.e. an optical path of 0.5-20 mm
<b>Probe end</b>	Stainless steel 316, 150-160 mm long x 12,7 mm (1/2") diameter. Waterproof.
<b>Jacketing</b>	The optical fibers are protected by a silicon inner tube and a flexible stainless steel (optional BX, O.D. 6.0 mm) or chrome plated brass (standard ME, 5.0 mm) outer jacket. Optionally a waterproof, steel reinforced, silicon tubing can be provided (-MS)
<b>Temperature</b>	-30°C to 100°C. (-HT version 200°C)
<b>Pressure</b>	Probe head 10 bar @ 25°C
<b>Bending</b>	Minimum bend radius: Short term (few seconds) 20 mm, long term: 120 mm

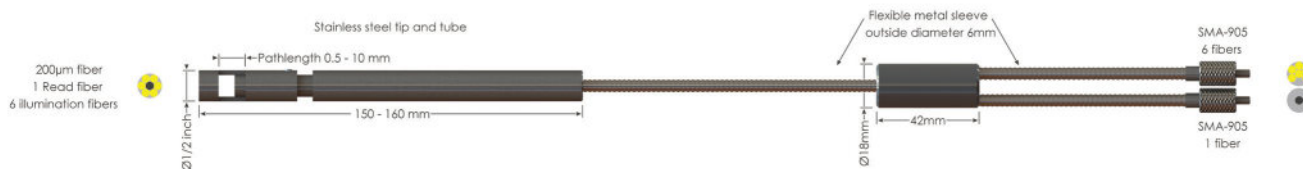

## FULL PRODUCT SPECIFICATIONS

Want to know the full product specifications, gratings selection, resolution table, accessories options and ordering information? Click [here](#) or scan the QR code on the right



# Custom Fiber Assemblies and Probes

For some applications, a specific fiber or probe is needed. Avantes has almost 30 years of experience designing custom probes for unique applications. Avantes has significant expertise in designing fiber optics for high temperature (HTX), high pressure (HP), vacuum, and other challenging conditions. Our wide variety of standard and custom materials can be configured to provide a fiber assembly that can meet the challenges of your environment.

Some examples of our special designs are displayed on the right of this page. Please get in touch with us to discuss your needs.

## High-temperature UV/VIS/NIR probe with gas connection

The universities of Bochum (Germany) and Utrecht (The Netherlands) approached us with a problem doing high-temperature measurements at low pressure of propane dehydrogenation: an ideal situation for creating cokes. Therefore every time the probe was contaminated with coke residue on the tip, they could only do a single test, after which they had to replace the probe.

Avantes responded by designing this high-temperature probe. It's resistant to temperatures of 700 degrees centigrade or more and features a connection for gas insertion into the probe. So far, during one test, the probe was continuously used for over 150 hours, with temperatures of 550-600 degrees. The gas used was nitrogen. The result was a clean tip, a reusable probe, and delighted customers.

## Chemical-resistant reflection probe

Standard reflection probes have a huge disadvantage in chemical environments: many chemicals interfere with the glue used to construct the probes. This version eliminates this disadvantage: all connections are mechanical, and sapphire windows and o-rings are used. The material used is stainless steel 310, which is also chemical resistant.

A reflection probe is inserted into the back of this probe, serving as a protective sleeve. The path length is variable and up to 30 mm.



## FULL PRODUCT SPECIFICATIONS

Want to know the full product specifications, gratings selection, resolution table, accessories options and ordering information? Click [here](#) or scan the QR code on the right



# Collimating Lenses

A collimating lens can be used to collect more light into a fiber optic cable. A collimating lens is needed to convert divergent beams of light into a parallel beam. Avantes collimating lenses are optimized for the UV/VIS/NIR range (200-2500 nm) and have anodized aluminum housings.

The COL-UV/VIS and COL-90-UV/VIS have a 6 mm diameter lens with a confocal length of 8.7 mm. The COL-90-UV/VIS is used when a 90-degree exit angle is needed. The focal point for the COL-UV/VIS and COL-90-UV/VIS can be adjusted. The COL-UV/VIS can also be ordered with an FC/PC connector.

The COL-UV/VIS-25 is the big brother of the COL-UV/VIS. It has a lens diameter of 25 mm and a confocal length of 50 mm. This larger collimating lens is suitable for the collection of light in free space.

**COL-UV/VIS**



**COL-90-UV/VIS**



## Technical Data

	COL-UV/VIS	COL-90-UV/VIS	COL-UV/VIS-25	DA-COL-SPEC
<b>Lens Diameter</b>	6 mm		25 mm	9 mm
<b>Lens focal length</b>	8.7 mm		50 mm	27 mm
<b>Lens Material</b>	UV grade Fused Silica			
<b>Wavelength range</b>	200-2500 nm			
<b>Fiber connection</b>	SMA-905, UNS 1/4" (standard, FC/PC also possible)			Direct attached
<b>Mirror reflectivity</b>	n.a.	>90% (200-1100 nm)		n.a.
<b>Housing Material</b>	Aluminum black anodized			
<b>Thread</b>	UNF 3/8"-24		n.a.	1/4"-36 UNS
<b>Lens focal length</b>	-30°C to 100°C (-HT version 200°C)		-30°C to 100°C	-30°C to 100°C (-HT version 200°C)

## FULL PRODUCT SPECIFICATIONS

Want to know the full product specifications, gratings selection, resolution table, accessories options and ordering information? Click [here](#) or scan the QR code on the right



# Cosine Correctors

Cosine correctors are used to collect light from a 180° angle. This eliminates optical interface problems associated with the light collection sampling geometry inherent to other sampling devices such as bare fiber-optics, collimating lenses or integrating spheres.

Avantes offers four different models of cosine correctors: The CC-VIS/NIR has a 3.9 mm active area and dimensions of 18 mm (L) X 6.5 mm (OD). The CC-VIS/NIR covers the full UV/VIS/NIR range of 200-2500 nm and is made of Quartz.

The CC-UV/VIS/NIR-8MM works as the CC-VIS/NIR but has an active area of 8.0 mm and dimensions of 29 mm (L) X 12 mm (OD). The specialized CC-UV/VIS/NIR-5.0 has a 20 mm active area is used for solar measurement applications requiring a 5° angular field of view, has a 20 mm active area, and is much larger than the other cosine correctors measuring 317 mm (L) X 38 mm (OD).

CC-VIS/NIR



CC-UV/VIS/NIR-8MM



## Technical Data

	CC-VIS/NIR	CC-UV/VIS/NIR-8MM	CC-DA-4.5	CC-UV/VIS/NIR-5.0
<b>Active area</b>	3.9 mm	8.0 mm	4.5 mm	20.0 mm
<b>Diffusing material</b>	Quartz (200-2500 nm), ca. 1.5 mm thick			
<b>Dimensions</b>	6.5 mm diameter, 18 mm long	12 mm diameter, 29 mm long	10 mm diameter, 13 mm long	38 mm diameter, 317 mm long
<b>Sampling geometry</b>	Accepts light at/from 180° FOV			Accepts light at 5° FOV
<b>Connector</b>	SMA-905	SMA-905	1/4"-36 UNS	SMA-905
<b>Temperature</b>	-30 °C to +100 °C			

## FULL PRODUCT SPECIFICATIONS

Want to know the full product specifications, gratings selection, resolution table, accessories options and ordering information? Click **here** or scan the QR code on the right



# Vacuum Feedthroughs

These feedthroughs are designed for use with fiber optics in vacuum chambers, such as for plasma and coating deposition monitoring. They can be used in chambers with 5-40 mm wall thicknesses and vacuum levels up to 10<sup>-7</sup> millibar.

The feedthrough assembly consists of an M12 housing with Viton® O-ring and two SMA fiber optic interconnects to allow easy coupling to fiber optic cables and probes. To connect these assemblies to fiber optic cables inside/outside the chamber, two extra SMA fiber interconnects (ME-FI-SM-MM) should be ordered separately.

The vacuum feedthrough can be delivered for all fiber diameters, from 50µm up to 1000 µm for UV/VIS/NIR. A high-temperature version of the vacuum feedthrough(-HT) is also available, enabling the device to withstand temperatures up to 200°C.



### Technical Data

<b>Fibers</b>	1 fiber, diameter 50 µm, 100 µm, 200 µm, 400 µm, 600 µm, 800 µm or 1000 µm
<b>Wavelength range</b>	200-800 nm (UV/VIS), 350-2500 (VIS/NIR) or 200-2500 nm (UV/VIS/NIR)
<b>Connectors</b>	Standard SMA-905 connectors (2x)
<b>Wall thickness of vacuum chamber</b>	5-40 mm
<b>Vacuum</b>	Max. 10 <sup>-7</sup> mbar
<b>Temperature</b>	-40°C to 100°C (-HT version 200°C)

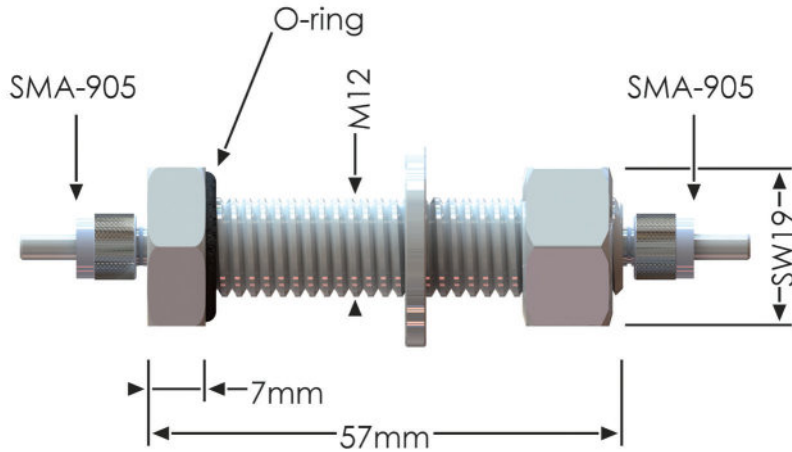

### FULL PRODUCT SPECIFICATIONS

Want to know the full product specifications, gratings selection, resolution table, accessories options and ordering information? Click [here](#) or scan the QR code on the right





# Fiber Optic Homogenizers

When connecting a multi-furcated fiber to a spectrometer or light source, light entering/exiting each of the fiber legs may or may not be uniform, so a fiber optic homogenizer can be used to mix the signals to provide a more consistent signal.

The compact MMA-UV/VIS-SMA fiber optic homogenizer is made of anodized aluminum and has female SMA-905 connectors on both ends. Internally, a highly transmissive Suprasil-Rod with a diameter of 1 or 3 mm transmits the light from one end to the other (from bundle to single fiber) and perfectly mixes the modes.

The fiber optic homogenizer can also be used as a mode stripper.



## Technical data

<b>Wavelength Range</b>	200-2000 nm
<b>Optical Rod Diameter Stabdurchmesser</b>	3 mm or 1 mm
<b>Lens Material</b>	Suprasil 1
<b>Housing Material I</b>	Aluminum anodized
<b>Fiber Connection</b>	SMA-905, UNS 1/4"
<b>Dimensions</b>	Length 47.5 mm, Diameter 14 mm
<b>Temperature</b>	-30 °C to +100 °C

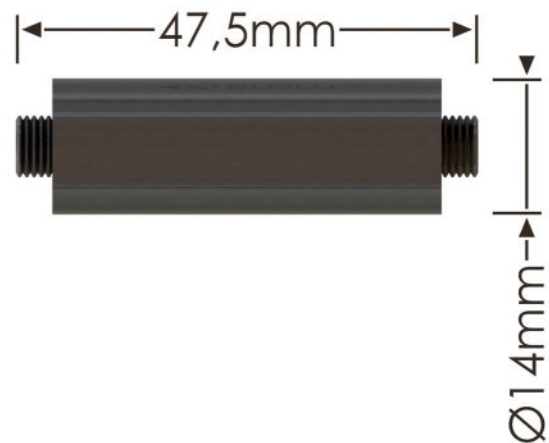

FIBER OPTICS

## FULL PRODUCT SPECIFICATIONS

Want to know the full product specifications, gratings selection, resolution table, accessories options and ordering information? Click **here** or scan the QR code on the right



# Fiber Microscope Adapters

To easily mount an Avantes spectrometer to a microscope, a C-mount adapter is available. It connects to an SMA or FC/PC fiber optic cable and features an outside diameter of 38 mm, 35 mm long to slide inside the tube of a microscope.

A special adapter with C-mount 1 inch-32 thread is available as AVS-MFA-SMA to screw onto a microscope.



### Technical Data

	AVS-MFA-SMA	AVS-CMOUNT-SMA	AVS-CMOUNT-FCPC
<b>Fiber-optic connection</b>	SMA	SMA	FC/PC
<b>Microscope mount</b>	1 inch-32 Cmount thread	38 mm diameter	38 mm diameter
<b>Material</b>	Black anodized aluminum		

### FULL PRODUCT SPECIFICATIONS

Want to know the full product specifications, gratings selection, resolution table, accessories options and ordering information? Click **here** or scan the QR code on the right



# Reflection Probe Holders

## RPH-1 Reflection Probe Holder

The RPH-1 is to be used with our standard reflection probes, which are 6.5 mm in diameter. The holder enables positioning of the probe tip in two angles: 45 degrees for diffuse reflection measurements and 90 degrees (typical to sample) for specular reflection. This assembly is mostly used to facilitate color measurements.

A set screw is included to mount the probe into position. The RPH-1 is a small device, measuring only 60 by 30 by 30 millimeters. It's made of black anodized aluminum.



## AFH-15 Angled Fiber Holder

To do an angled measurement with a small 1.5 mm reflection probe or 1.5 mm stainless steel ferrule terminated fibers, the AFH-15 is the ideal accessory. Offering angles including 15°, 30°, 45°, 60°, 75° and 90°, reflection measurements with differing incident and collection angles can be easily made with multiple, separate fibers for illumination and detection.

All 11 holes have a diameter of 1.6 mm and are equipped with a set screw to mount the probes or fibers into position. The AFH-15 is made of black anodized aluminum.



## AFH-Ocular

Measurements on a small spot (less than 0.5 mm) can be challenging, but the AFH-Ocular makes the job easier. The ocular enables the visual location of the measurement spot on your sample. The holder is used in conjunction with our miniaturized reflection probe (FCR-7UV100-2-1x25), which has 7 x 100 μm fibers in a 6 around 1 configuration, and the tip is 1 mm in diameter x 25 mm long.

Please note that a black cover over the ocular (not included) should be used during measuring to prevent ambient light from reaching the measurement spot.



## FULL PRODUCT SPECIFICATIONS

Want to know the full product specifications, gratings selection, resolution table, accessories options and ordering information? Click [here](#) or scan the QR code on the right



# T/R Stages for Transmission and Reflection

This transmission and reflection stage is the ideal companion to make it easier to perform reflection and transmission measurements. The TR-Stage is a great accessory for performing and creating multiple measurement setups.

The TR-stage consists of 3 different elements:

- The top plate can hold a COL-UV/VIS (included) or a 6.35 mm reflection probe. It also has a cover to shield against ambient light.
- The middle plate is intended to place the sample on.
- The bottom plate can be used to mount or position a COL-UV/VIS, AvaSphere-xx-IRRAD (xx= 30 or 50) or WS-2 Reference tile. With an additional plate, the TR-LSHAL-Holder, it can be used in combination with the AvaSphere-50-LS-HAL-12V as well (not included).



## FULL PRODUCT SPECIFICATIONS

Want to know the full product specifications, gratings selection, resolution table, accessories options and ordering information?  
Click [here](#) or scan the QR code on the right



# Fiber Interconnects

To connect one fiber to another, a fiber interconnect is needed. They can be useful for coupling patch cords to fiber optic probes and other devices or for any multiple-fiber application where coupling standard optical fibers and accessories is preferable to creating costly and complex fiber optic assemblies.

## Bulkheads

Avantes bulkhead adaptors for TO-5 and TO-18 packages are ideal for coupling an LED to a fiber-optic cable: the back side has space for an LED.

**ME-FI-SM-MM SMA interconnect**



**ME-FI-FC/PC-MM FC/PC interconnect**



**ME-SM-BC SMA Bulkhead**

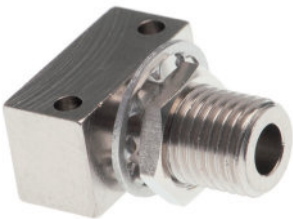

**ME-FCPC-BC FC/PC Bulkhead**

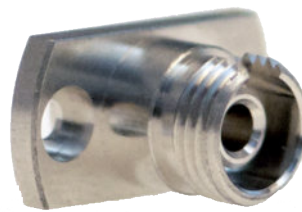

FIBER OPTICS

## FULL PRODUCT SPECIFICATIONS

Want to know the full product specifications, gratings selection, resolution table, accessories options and ordering information? Click **here** or scan the QR code on the right





# ACCESSORIES

## INTRODUCTION

In the pursuit of excellence and accuracy in spectroscopic measurements, Avantes proudly presents an extensive array of high-quality accessories. Designed to facilitate seamless experimentation, our accessories range from integrating spheres to cuvette holders, filter holders, fiber-optic multiplexers, and more, providing comprehensive solutions for all your fiber-optic accessory needs.

At Avantes, we understand the significance of precision, versatility, and reliability in spectroscopy. Our accessories are thoughtfully designed and meticulously crafted to complement our spectrometers, elevating your measurements to new heights.

**Our diverse range of accessories can be divided into several categories, each catering to specific measurement requirements:**

Cuvette Holders

Integrating Spheres

AvaTrigger External Triggerbox.

Inline or Direct-Attached Filter Holders and TTL-Controlled Shutters

Fiber-Optic Attenuator

Fiber-Optic Multiplexer

Optical Table Mounts

Flow Cells

White and Specular Reflection Tiles/Standards

Power Adapters and Battery Packs

## **MORE INFORMATION**



Find an overview of our accessories on our website. Click [here](#) or scan the QR code to find all accessories on one page.

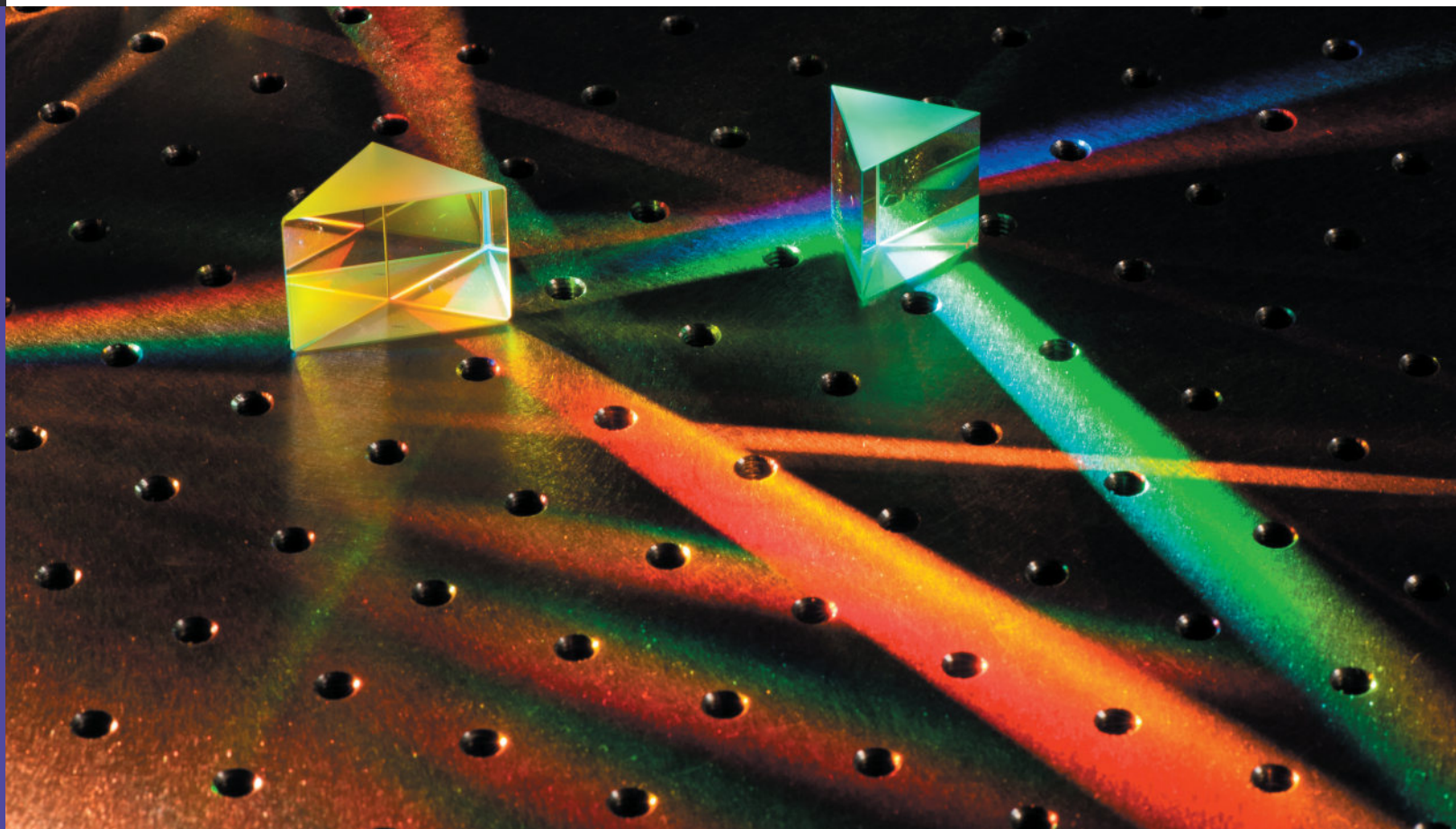

# Cuvette Sample Holders

The CUV-UV/VIS, CUV-FL-UV/VIS, and CUV-ALL-UV/VIS are specially designed for absorption and fluorescence measurements and should be used with standard 10x10 mm cuvettes. Adjustable ball detents ensure repeatable placement and measurements at the same location for non-standard cuvettes. All cuvette holders have a 5 mm wide slit to hold filters and a cover to prevent ambient light from entering the light path.

The CUV-UV/VIS features two COL-UV/VIS collimating lenses with adjustable focus to maximize light throughput.

**CUV- UV/VIS**

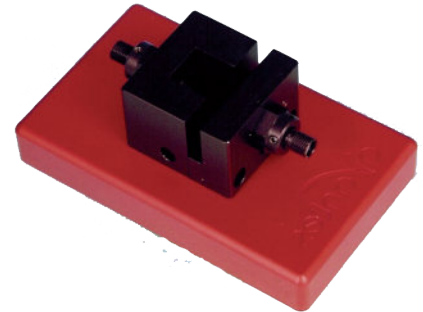

**CUV-ALL-UV/VIS**

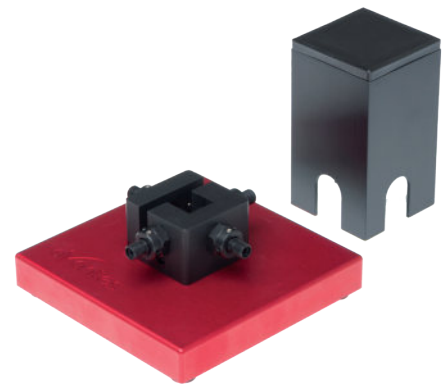

The CUV-FL-UV/VIS has the same specifications, but the collimating lenses are placed under an angle of 90 degrees for fluorescence measurements (to isolate excitation from emission wavelengths).

The other two ports on the CUV-FL-UV/VIS have SiO<sub>2</sub>-coated aluminum mirrors (CUV-FL-MIRROR) to enhance the excitation and fluorescence signals.

The CUV-ALL-UV/VIS features four collimating lenses, all COL-UV/VIS, in two optical paths.

For UV measurement, Avantes offers quartz cuvettes. The CUV-10-2 has two optical windows for absorption measurements. The CUV-10-4 features four optical windows, ideal for fluorescence with the CUV-FL-UV/VIS or dual path measurements with the CUV-ALL-UV/VIS.

## Technical Data

	CUV-UV/VIS	CUV-FL-UV/VIS	CUV-ALL-UV/VIS
<b>Cuvette Dimensions</b>	10 x 10 mm (lightpath)		
<b>Fiber connection</b>	2 x COL-UV/VIS, SMA	2 x COL-UV/VIS, SMA, 2 mirrors	4 x COL-UV/VIS, SMA
<b>Filter slot</b>	Max 5 mm wide		
<b>Overall dimensions</b>	100 x 60 x 40 mm	100 x 100 x 40 mm	
<b>Cover</b>	Black anodized aluminum with black PE insert, 45 x 45 x 80 mm		

## FULL PRODUCT SPECIFICATIONS

Want to know the full product specifications, gratings selection, resolution table, accessories options and ordering information? Click [here](#) or scan the QR code on the right





# Temperature-Controlled Cuvette Holders

Avantes offers the CUV-UV/VIS-TC, an air-cooled temperature-controlled cuvette holder for extra stability during demanding measurements such as fluorescence. The temperature can be set anywhere between -15 and +105 with an accuracy of 0.15.

Other features include magnetic stirring, slit attenuation kit, and fused-silica lens systems with SMA fiber optic connectors. It can be combined with any AvaLight light source or AvaSpec spectrometer to create a powerful measurement system.

The CUV-UV/VIS-TC is available in fluorescence, absorption, or combined fluorescence/absorption configurations.

Application areas enabled by the CUV-UV/VIS-TC series include DNA melting and annealing, protein thermodynamics, fluorophore characterization, enzyme kinetics, and online thermocycling of biological particles.

## CUV-UV/VIS-TC



### Technical Data

<b>Cuvette Dimensions</b>	10 x 10 mm (lightpath); outside 12.5 x 12.5 mm
<b>Fiber connection</b>	SMA
<b>Normal factory set temperature range</b>	-40°C to +105°C
<b>Temperature range easily achievable</b>	-15 °C to +105 °C
<b>Range with special techniques</b>	-30 °C to +105 °C
<b>Temperature precision</b>	± 0.01 °C
<b>Temperature accuracy</b>	± 0.15 °C from -20 °C to +105 °C
<b>Magnetic stirring motor type</b>	Stepper
<b>Magnetic stirring speed range</b>	1-2500 rpm
<b>Default stirring speed</b>	1200 rpm
<b>Stirring speed best performance</b>	60-1800 rpm
<b>Overall dimensions</b>	122 x 122 x 119 mm
<b>Control unit</b>	Integrated, via software on PC for temp and stirring

## FULL PRODUCT SPECIFICATIONS

Want to know the full product specifications, gratings selection, resolution table, accessories options and ordering information? Click [here](#) or scan the QR code on the right



## Slit Kit - Replaceable slits, including tools

To fully utilize your AvaSpec-RS series spectrometer with a replaceable slit, the Slit Kit is available. It features a complete set with four slits of 25, 50, 100, 200, and 500  $\mu\text{m}$ . Also included in the kit are the tools to easily change the slit.

The Slit Kit is available in SMA (choice of 4 SMA slits), SMA/FCPC (combination of 2 SMA and 2 PCPC slits), and FC/PC (choice of 4 FCPC and/or SMA slits) versions. All kits can be used on any spectrometer with the replaceable slit option installed.

Slit sizes 5 and 10  $\mu\text{m}$  cannot be included in the kit but can be ordered separately (recalibration of spectrometer recommended).



### Technical Data

<b>Slit set connectors</b>	SMA-905 or FC/PC
<b>Slit sizes</b>	25, 50, 100, 200, 500 $\mu\text{m}$ (width) x 1 mm (height)
<b>Material</b>	Stainless steel
<b>Fixing screws</b>	Torx (included)

### FULL PRODUCT SPECIFICATIONS

Want to know the full product specifications, gratings selection, resolution table, accessories options and ordering information? Click **here** or scan the QR code on the right



# Direct-Attach Variable In-line Filter Holder

As part of the wide range of direct-attach accessories, Avantes offers the FH-DA series of filter holders. They can hold 0.5-inch filters 1-8 mm thick.

The filter holders are equipped with a quartz-collimating lens for the UV/VIS/NIR range. Avantes offers a wide range of round 12 mm filters.

The FH-DA is available in two versions: one for the Avalight-XE and Avalight-DHc and one for the AvaLight-HPLED. The FH-DA-HAL is designed to work seamlessly with the AvaLight-HAL.

**FH-DA**



## Technical Data

	FH-DA	FH-DA-HAL-Mini
<b>Wavelength range</b>	200-2500 nm	
<b>Filter Dimensions</b>	Round, 13 mm diameter, 1-8 mm thick	
<b>Fiber connection</b>	SMA-905 connector	
<b>Light source</b>	AvaLight-DHc/XE/LED	AvaLight-HAL-Mini
<b>Light source mounting</b>	SMA-905 thread	UNS thread (remove COL-UV/VIS)
<b>Material</b>	Black anodized aluminum	
<b>Dimensions</b>	44.5 x round 20 mm	37 x 40 x 41 mm

## FULL PRODUCT SPECIFICATIONS

Want to know the full product specifications, gratings selection, resolution table, accessories options and ordering information? Click **here** or scan the QR code on the right



# Direct-Attach Cuvette Holders

To mount a cuvette holder directly to your light source, Avantes offers a range of direct-attached cuvette holders. The CUV-DA connects to the AvaLight-DHc, -XE, and -(HP)LED light sources, the CUV-DA-DHS to the AvaLight-DHS and AvaLight-DHS-BAL and the CUV-DA-HAL to the AvaLight-HAL. These devices can be used for either absorbance or fluorescence measurements.

All CUV-DA cuvette holders feature two 90-degree and one 180-degree threads that allow the COL-UV/VIS collimating lens to be connected for absorbance or fluorescence setups. Each CUV-DA series cuvette holder includes two SiO<sub>2</sub> aluminum mirrors to enhance fluorescence signals further. These are mounted at 90 degrees to the excitation source and emission output. The CUV-DA has a 5 mm wide filter slot.

For the AvaLight-HAL and the AvaLight-DHS, the direct-attached cuvette holders can be mounted directly on the front panel of the light source by removing the standard filter holder.

**CUV-DA**



## Technical Data

	CUV-DA			CUV-DA-DHS	CUV-DA-HAL-Mini
<b>Lightsource</b>	AvaLight-DHc	AvaLight-(HP) LED	AvaLight-XE	AvaLight-DH-S	AvaLight-HAL-Mini
<b>Wavelength range</b>	200-2500 nm				
<b>Cuvette Dimensions</b>	10 x 10 mm (lightpath)				
<b>Light source connection</b>	SMA thread incl col. lens			Mounting plate	UNS-thread (remove COL-UV/VIS)
<b>Fiber connection</b>	1 x COL-UV/VIS, SMA-905 connectors				
<b>Fluorescence mirrors</b>	2 x SiO <sub>2</sub> coated aluminum mirrors				
<b>Filter slit</b>	Max. 5 mm wide				n.a.
<b>Dimensions</b>	60 x 43 x 28 mm			60x 50 x 50 mm	60x 35 x 35 mm

## FULL PRODUCT SPECIFICATIONS

Want to know the full product specifications, gratings selection, resolution table, accessories options and ordering information? Click [here](#) or scan the QR code on the right



# Direct-Attach Fiber Optic Attenuators

When light intensity has to be reduced, the direct-attached attenuator is a great choice with your AvaLight series light sources. The attenuator helps in situations where detector saturation is an issue. It is attached to the light source and has an SMA connector to couple to other measurement devices and your spectrometer.

The attenuation can be set from 0-100%, which can be fixed with a set screw. It is supplied with a UV/VIS/NIR collimating lens.

The ATT-DA series attenuators come in two versions: the ATT-DA is meant to be used with the AvaLight-DHc, the AvaLight-XE, and AvaLight-HPLED.

The ATT-DA-HAL is meant to be used with an AvaLight-HAL light source.

**ATT-DA**



## Technical Data

	ATT-DA	ATT-DA-HAL-Mini
<b>Wavelength range</b>	200-2500 nm	
<b>Attenuation</b>	0-100%	
<b>Iris aperture</b>	0.0 – 12.0 mm	
<b>Iris construction</b>	2 x 5 leaves	
<b>Fiber connection</b>	SMA-905 connector	
<b>Light source</b>	AvaLight-DHc/XE/LED	AvaLight-HAL-Mini
<b>Light source mounting</b>	SMA-905 thread	UNS-thread (remove COL-UV/VIS)
<b>Material</b>	Black anodized aluminum	
<b>Dimensions</b>	27 mm round x 49 mm	37 x 41 x 57 mm

## FULL PRODUCT SPECIFICATIONS

Want to know the full product specifications, gratings selection, resolution table, accessories options and ordering information? Click **here** or scan the QR code on the right



# Cuvette Holders with Attenuator and Filter Holder

Have the most flexible setup with the combined cuvette holder, attenuator, and filter holder. You can control the light throughput from 0-100%, which can be fixed with a set screw. Use the cuvette holder for any cuvette up to 10x10 mm and add half-inch diameter (12-13 mm) filters of 1-8 mm thick.

The combined direct-attached accessory is available in two versions: the CUV-ATT-DA is used with the AvaLight-DHc (Deuterium and Halogen), AvaLight-XE (Xenon) and AvaLight-HPLED. The CUV-ATT-DA-HAL is meant for the AvaLight-HAL (Halogen) light source.

CUV-ATT-DA



## Technical Data

	CUV-ATT-DA	CUV-ATT-DA-HAL-Mini
<b>Wavelength range</b>	200-2500 nm	
<b>Cuvette Dimensions</b>	10 x 10 mm (lightpath)	
<b>Attenuation</b>	0-100%	
<b>Filter slit</b>	Max 5 mm wide	
<b>Fiber connection</b>	SMA-905 connector	
<b>Fluorescence mirrors</b>	2 x SiO <sub>2</sub> coated aluminum mirrors	
<b>Light source</b>	AvaLight-DHc/XE/LED	AvaLight-HAL-Mini
<b>Light source mounting</b>	SMA-905 thread	UNS-thread (remove COL-UV/VIS)
<b>Material</b>	Black anodized aluminum	
<b>Dimensions</b>	42 x 34 x 85 mm	42 x 45 x 93 mm

## FULL PRODUCT SPECIFICATIONS

Want to know the full product specifications, gratings selection, resolution table, accessories options and ordering information? Click [here](#) or scan the QR code on the right



# Variable In-Line Filter Holders

When an in-line filter is needed, Avantes offers two types of in-line filter holders: the FH-INLINE-1" and the FH-INLINE. The FH-INLINE-1" is designed to hold one-inch filters from 1-60 mm thick. The FH-INLINE is designed for 1/2" or 12-13 mm filters of 1-8 mm thick.

Both in-line filter holders come with two quartz-collimating lenses for the UV/VIS/NIR range. Avantes offers a wide range of round 12 mm filters (for FH-INLINE). For more specifications, please see the table below.

**FH-INLINE-1"**

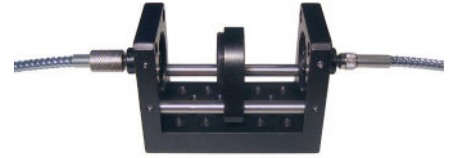

**FH-INLINE**



## Technical Data

	FH-INLINE	FH-INLINE-1"
<b>Wavelength range</b>	200-2500 nm	
<b>Filter Dimensions</b>	Round, 12-13 mm diameter, 1-8 mm thick	Round, max 1 inch (25.4 mm) diameter, 1-60 mm thick
<b>Fiber connection</b>	2 SMA-905 connectors	
<b>Material</b>	Black anodized aluminum	
<b>Dimensions</b>	round 20 x 50 mm	81 x 41 x 51 mm

## Separate Round Filters

<b>GL-WG305-3-12</b>	Separate 12 x 3 mm long-pass filter > 305 nm
<b>GL-KG3-3-12</b>	Separate 12 x 3 mm band-pass filter, transparent > 325 nm and < 700 nm
<b>GL-GG395-3-12.5</b>	Separate 12 x 3 mm long-pass filter > 395 nm
<b>GL-GG475-3-12</b>	Separate 12 x 3 mm long-pass filter > 475 nm
<b>GL-OG515-3-12</b>	Separate 12 x 3 mm long-pass filter > 515 nm
<b>GL-OG550-3-12</b>	Separate 12 x 3 mm long-pass filter > 550 nm
<b>GL-NG9-1-12</b>	Separate 12 x 1 mm Neutral Density filter, (transmission 10%, 400-1100 nm)
<b>GL-NG9-2-12</b>	Separate 12 x 2 mm Neutral Density filter, (transmission 1%, 400-1100 nm)
<b>GL-NG9-3-12</b>	Separate 12 x 3 mm Neutral Density filter, (transmission 0.1%, 400-1100 nm)

## FULL PRODUCT SPECIFICATIONS

Want to know the full product specifications, gratings selection, resolution table, accessories options and ordering information? Click **here** or scan the QR code on the right



# In-Line Fiber Optic Attenuators

For all UV-VIS-NIR applications and ATT-INL-EXT setups where light intensity has to be reduced, Avantes offers the inline fiber optic attenuator (ATT-INL-EXT) and the direct-attached fiber optic attenuator (ATTDA). This device is an iris attenuator that controls light throughput to avoid detector saturation. The ATT-INL-EXT is coupled between two SMA-terminated fiber optic cables, whereas the ATT-DA can be connected directly to the light source. Both devices have two UV/VIS/NIR collimating lenses mounted on either side of an adjustable iris. The attenuation can be set from 0-100% and can be fixed with a set screw.

**ATT-INL-EXT**



### Technical Data

<b>Wavelength range</b>	200-2500 nm
<b>Attenuation</b>	0-100%
<b>Iris aperture</b>	0.0 – 12.0 mm
<b>Iris construction</b>	2 x 5 leaves
<b>Fiber connection</b>	2 SMA-905 connectors, incl. 2 COL-UV/VIS collimating lenses
<b>Material</b>	Black anodized aluminum
<b>Dimensions</b>	60 x Ø 25 mm

### FULL PRODUCT SPECIFICATIONS

Want to know the full product specifications, gratings selection, resolution table, accessories options and ordering information? Click **here** or scan the QR code on the right





# Variable Pathlength Cuvette Holders

The CUV-VAR-UV/VIS cuvette holder is the ideal solution for low absorption measurements and flow cell cuvettes.

It features a variable, adjustable path length, ranging from 10-160 mm, ensuring maximum flexibility. It can be used as a standard cuvette holder with a 10 mm path length, a filter holder with a 2 mm path length, or any path length up to 160 mm.

This item is equipped with two COL-UV/VIS collimating lenses to support applications in the 200-2500 nm wavelength range.

## CUV-VAR-UV/VIS

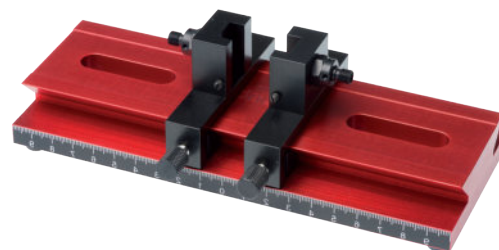

### Technical Data

<b>Base Dimensions (L x W x H)</b>	200 x 80 x 25 mm
<b>Fiber connection</b>	2 x COL-UV/VIS, SMA connectors
<b>Optical path</b>	10-160 mm
<b>Cuvette holder insert</b>	Minimal optical path 10 mm.
<b>Focal height</b>	15 mm from base plate
<b>Overall dimensions (L x W x H)</b>	200 x 96 x 62 mm

### FULL PRODUCT SPECIFICATIONS

Want to know the full product specifications, gratings selection, resolution table, accessories options and ordering information? Click **here** or scan the QR code on the right



# Integrating Spheres

An integrating sphere works as a light collector. The light collected can be used as a diffuse illumination or measurement source. The basic principle is that light enters the sphere through the sample port, goes through multiple reflections on the highly reflective, Lambertian surface of the sphere, and is scattered uniformly around the interior of the sphere. Behind a baffled port inside the sphere which is independent of the angular properties of the sample port, a fiber-optic cable collects a homogenized light signal and carries it to the spectrometer. The baffle is significant as it prevents first reflections from entering the detection fiber.

The AvaSphere series integrating spheres are available with active diameters of 30, 50, and 80 mm and an SMA port at 90 degrees for collecting the irradiance and reflection signals. The reflection spheres feature an additional SMA-connector port at 8 degrees from normal (from sample port) for direct illumination. This port couples external light into the sphere through a fiber-optic cable connected to a COL-UV/VIS collimating lens. The sample port diameters are 6 mm for the AvaSphere-30, 10 mm for the AvaSphere-50, and 15 mm for the AvaSphere-80.

All sample ports are knife-edge, ensuring a nearly 180-degree field of view of the sample port. The integrating sphere's irradiance version can be used to measure light sources, such as lasers, LEDs, and incandescent sources.

For irradiance measurements of 5 mm cylindrical LEDs, a special adapter is available for the AvaSphere-50/80-IRRAD. This adapter ensures correct and reproducible positioning of the LEDs inside the sphere.

The AvaSphere reflection version is used to measure the total integrated reflectance of a surface for color measurements and fluorescence spectroscopy on solids/powders. The principle of measurement is based on direct illumination and indirect reflection. The AvaSphere-50-LS-HAL with an internal light source can be used as a uniform source and is available with an intensity calibration file.

The inside of the integrating spheres is made of a highly reflective diffuse PTFE material. This provides over 96% reflectance over a wide wavelength range of 250-2500 nm. For the AvaSphere-50-REFL, a special black gloss trap is available to exclude specular reflection in the measurement. Please order this option when ordering the sphere. In case specular reflection needs to be included, a white reflective part, which is standard on all AvaSphere-50-REFL, can be mounted in the position of the gloss trap.

**AvaSphere-30-REFL**



## Technical Data

	AvaSphere-30	AvaSphere-50	AvaSphere-80
<b>Internal diameter (mm)</b>	30	50	80
<b>Sample port diameter (mm)</b>	6	10	15
<b>External Dimensions</b>	59.5 mm diameter 40 mm height	69.5 mm diameter 60 mm height	109 mm diameter 95 mm height

## FULL PRODUCT SPECIFICATIONS

Want to know the full product specifications, gratings selection, resolution table, accessories options and ordering information?  
Click [here](#) or scan the QR code on the right



# Integrating Spheres with Internal Halogen Light Source

Providing up to 160 times more light on your sample for a reflection measurement relative to our standard reflectance integrating sphere, the AvaSphere-50-LS-HAL-12V is a valuable instrument for reflection applications. It is a combination of an integrating sphere and a halogen light source. The sphere provides diffused halogen light on your sample without the losses associated with fiber-optic coupling. It has a direct collimated SMA port for the collection of the reflection signal with any of our AvaSpec spectrometers.

It's mostly useful for dark or low-reflecting materials and NIR spectral measurements where signal strength can be limited. It is also beneficial for measuring gemstones.

The AvaSphere-50-LS-HAL-12V has an internal diameter of 50 mm, a sample port of 10 mm, and an SMA-terminated reference port. The 5W halogen lamp is stabilized and cooled with forced airflow. A 12V power supply is included.

The switch line makes it possible to remotely switch the light source on/off with a TTL signal.



## Technical Data

<b>Wavelength range</b>	360-2500 nm
<b>Internal diameter</b>	50 mm
<b>Sample port diameter</b>	10 mm
<b>Color temperature</b>	2850 K
<b>Stability/Drift</b>	< 0.1% / h
<b>Bulb life</b>	4.000 hrs
<b>Power requirement</b>	12VDC, 1A
<b>External Dimensions</b>	70 mm diameter, 82,5 mm height

## FULL PRODUCT SPECIFICATIONS

Want to know the full product specifications, gratings selection, resolution table, accessories options and ordering information? Click **here** or scan the QR code on the right



# Large Integrating Spheres

For measurement of high-powered LEDs and sources, Avantes offers the AvaSphere-100, -150, and -200. The number corresponds with the internal diameter of the spheres in millimeters.

The 100, 150, and 200 models have three ports: 0, 90 degrees, and NP. The port you choose is fitted with a baffled SMA-905 connector; please specify when ordering. Either of the other two ports can be used for illumination or sampling. The default sample port sizes are typically 25% of the sphere's diameter. Port plugs or reducers are available on request.

All spheres can be attached to spectrometers via fiber optic cables, and the entire system can be irradiance calibrated to measure the total flux of a lamp under test.



## Technical Data

	AvaSphere-100	AvaSphere-150	AvaSphere-200
<b>Wavelength range</b>	400-1100 nm	400-1100 nm	400-1100 nm
<b>Internal diameter</b>	102 mm	152 mm	203 mm
<b>Port diameters</b>	25.4 mm	38.1 mm	50.8 mm
<b>Port Reducers</b>	10 mm	10 mm	10 mm
<b>External Dimensions</b>	118 mm	168 mm	218 mm

## FULL PRODUCT SPECIFICATIONS

Want to know the full product specifications, gratings selection, resolution table, accessories options and ordering information? Click [here](#) or scan the QR code on the right



# Variable Collimating Lens Holders

The variable collimating lens holder is the perfect tool for transmission measurements of samples of various sizes and thicknesses. The vertical bars can be adjusted to samples up to 160 mm thick. The base is made of anodized aluminum and features adjustable mount bars. Each bar has four 3/8"-24 threaded holes for COL-UV/VIS collimating lenses. Adjusting the bars is easy; loosen the screws and slide.

The variable collimating lens holder includes two COL-UV/VIS collimating lenses.

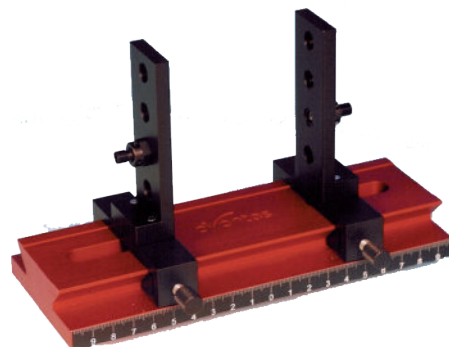

## Technical Data

	Base	Mounting bars
<b>Dimensions</b>	200 x 80 x 25 mm, total height 120 mm	35 x 7 mm thick
<b>Threads</b>	n.a.	4 holes 3/8"-24, 20 mm apart
<b>Collimating Lenses</b>	n.a.	2 COL-UV/VIS

## FULL PRODUCT SPECIFICATIONS

Want to know the full product specifications, gratings selection, resolution table, accessories options and ordering information? Click **here** or scan the QR code on the right



# AvaTripod

The AvaTripod is a flexible and versatile accessory that is useable in various applications.

The top of the tripod has an attachment head that features two holes, one measuring 6.8 mm in diameter to hold the barrel of a cosine corrector (CC-VIS/NIR) or a reflection probe and a set screw to hold the probe or cosine corrector in place.

The second hole is a 3/8"-24 threaded for a COL-UV/VIS collimating lens.

The head can be fixed at any position or angle with an adjustable height of 200-300 mm.



## Technical Data

<b>Dimensions</b>	250 x 250 x 300 mm Max 75 x 75 x 200 mm (folded)
<b>Threads</b>	1 hole 3/8"-24 for COL-UV/VIS collimating lens 1 hole 6.8 mm diameter with setscrew for FCR probes and cosine correctors
<b>Height adjustment</b>	200-300 mm

## FULL PRODUCT SPECIFICATIONS

Want to know the full product specifications, gratings selection, resolution table, accessories options and ordering information?  
Click **here** or scan the QR code on the right



# AvaTrigger External Trigger Box

The AvaTrigger is designed for use with any AvaSpec-USB2/EVO spectrometer; it enables two external triggering methods: optical and manual.

The optical trigger is useful for measuring pulsed light sources, such as solar simulations. Your Avantes spectrometer can start integrating within 1.5 microseconds after receiving the signal from the AvaTrigger. Alternatively, you can specify a delay time to measure spectral output against time (temporal stability). The AvaTrigger has an SMA-905 connector to easily couple with any accessory or light source from Avantes' line-up.



The sensitivity of the optotrigger can be adjusted by a potentiometer at the front. A green indicator LED on the front panel of the AvaTrigger shows a short pulse when a TTL pulse is sent to your spectrometer.

The IC-DB26-2 interface cable required to connect the AvaTrigger with your Avantes EVO spectrometer is included in the box.

## Technical Data

<b>Trigger Input</b>	Opto	Pushbutton
<b>Internal Delay time to TTL output</b>	Ca. 300 ns*	20 µsec
<b>Minimal pulse duration Trigger in</b>	10 µsec	
<b>Power consumption</b>	5 mA @ 5VDC (internal)	
<b>IO connector to AvaSpec</b>	Pin 3 (5VDC), Pin 4 (hardware trigger to AvaSpec), pin 8 (enable trigger), pin 10 GND	
<b>Dimensions</b>	75 x 78 x 37 mm	
<b>Weight</b>	260 g	

\*depending on the slew rate of the light source

## FULL PRODUCT SPECIFICATIONS

Want to know the full product specifications, gratings selection, resolution table, accessories options and ordering information? Click **here** or scan the QR code on the right



# Fiber Optic Switch (FOS-2-INL)

AAvantes' fiber optic switch (FOS) is the ideal accessory to correct light source drift. This FOS is operated electronically via TTL signals from an external source or one of our AvaSpec spectrometers. TTL signals can be provided by an external device or an AvaSpec spectrometer connected via an interface cable.

The FOS is coupled in the optical paths between SMA-terminated fibers and features four COL-UV/VIS collimating lenses (UV/VIS/NIR).

Both light paths can be controlled independently via the two TTL signals.

The industrial-graded shutter motors inside support the instrument's heavy usage. With its 5 million cycles, 24/7 operation is supported in most cases.

To operate the FOS, a PS-12V/2.08A power supply and interface cable are required (ordered separately).



## Technical Data

<b>Wavelength range</b>	200 - 2500 nm
<b>Fiber connection</b>	4 SMA-905 connectors, incl. 4 COL-UV/VIS collimating lenses
<b>Shutter frequency</b>	Max. 5 Hz
<b>Shutter delay</b>	15 ms
<b>Shutter attenuation</b>	-1.0 dB*
<b>Material</b>	Black anodized aluminum
<b>Dimensions</b>	34 x 58 x 45 mm
<b>Lifetime shutter</b>	5,000,000 cycles (typical)
<b>Power</b>	12V DC/500 mA

## FULL PRODUCT SPECIFICATIONS

Want to know the full product specifications, gratings selection, resolution table, accessories options and ordering information? Click **here** or scan the QR code on the right





# Direct-Attach Shutter

A good dark measurement is necessary for accurate results during transmission, absorption, reflection, irradiance, or color measurement at different integration times. Taking this dark measurement often leads to having to undertake manual actions, like covering the sensor or switching off the light. This might be problematic with certain applications because of the time and place or operator restraints.

Our solution: a remote-controlled shutter positioned between the spectrometer entrance and the input fiber.

Avantes' direct-attach shutter is the ideal accessory to facilitate the automatic shuttering of a spectrometer. This shutter is operated via TTL pulses from an external source or an AvaSpec spectrometer through a cable (IC-DB26-AS-SHUTTER-0.6, to be ordered separately).

The DA-Shutter switch unit is directly attached to the spectrometer's SMA input connector. The fiber normally connected to the spectrometer is then connected to the DA-Shutter. This switch unit and the power source, and the TTL control signal are connected to the control box.

The industrial-graded shutter motor used inside will support heavy usage of the instrument. With its 5,000,000 cycles, 24/7 operation is supported in most cases.

To operate the DA-Shutter, a PS-12V/2.08A 12-volt DC power adapter is required (to be ordered separately).



## Technical Data

<b>Wavelength range</b>	200-2500 nm
<b>Fiber connection</b>	SMA-905 connector
<b>Spectrometer connection</b>	SMA-905 connector (female)
<b>Shutter frequency</b>	Max. 5 Hz
<b>Shutter delay</b>	15 ms
<b>Attenuation/amplification DA-Shutter</b>	+0.6 dB (AvaSpec HSC/HERO), -1.5 dB (AvaSpec HSC/NIR)*, +0.6 dB (AvaSpec-ULS/Mini)
<b>Material</b>	Black anodized aluminum
<b>Dimensions switch unit (DxH)</b>	30 x 38 mm
<b>Dimensions control box (HxLxW)</b>	28 x 58 x 45 mm
<b>Power</b>	12V DC/500 mA
<b>Lifetime shutter</b>	5,000,000 cycles (typical)

## FULL PRODUCT SPECIFICATIONS

Want to know the full product specifications, gratings selection, resolution table, accessories options and ordering information? Click **here** or scan the QR code on the right



# Fiber Optic Multiplexer (FOM)

To configure systems that enable a single light source and spectrometer to make multi-point serial measurements, Avantes offers the FOM fiber optic multiplexer. The device is available in three different configurations: 1 input to 16 outputs, 2 inputs to 8 outputs or 4 inputs to 4 outputs. The FOM consists of a precisely controlled stepper motor and a rotary block. The optical path is coupled through multiple COL-UV/VIS collimating lenses.

The fiber-optic multiplexer is controlled via a USB connection to a PC. The FOM software enables full control over the switching order, switching time, and delay time and operates as a stand-alone unit. To integrate the FOM with AvaSpec spectrometers and your own devices, the FOM-DLL software development kit is available and should be ordered separately.

Applications for the FOM include process control, where multiple locations need to be measured with multiple probes, all with one spectrometer and/or light source.



## Technical Data

	FOM-UVIR400-1x16	FOM-UVIR400-2x8	FOM-UVIR400-4x4
<b>Multiplex Channels</b>	1 x 16	2 x 8	4 x 4
<b>Optical Throughput</b>	> 60 % (based on 400 µm fibers)		
<b>Wavelength Range</b>	200-2500 nm (UV/VIS/NIR)		
<b>Fibers</b>	Standard max. 400 µm, different dimensions available on request		
<b>Connectors</b>	All SMA-905		
<b>Optical Repeatability</b>	> 99%		
<b>Switching Time</b>	< 225 ms between adjacent positions		
<b>Interface</b>	USB 2.0		
<b>Power Requirement</b>	100-230 VAC, 60VA		
<b>Dimensions</b>	244 x 144 x 354 mm		

## FULL PRODUCT SPECIFICATIONS

Want to know the full product specifications, gratings selection, resolution table, accessories options and ordering information? Click [here](#) or scan the QR code on the right



# Direct-attach Beam Splitter/Combiner

The Beam Splitter gives you a flexible option for using dual light sources or spectrometers. The small size of the beam splitter allows it to be directly mounted to the front of any AvaSpec spectrometer or AvaLight light source, eliminating the fiber interface. Another advantage is that your existing systems can be easily upgraded to a two-channel system. Being highly adaptable, the Beam Splitter enables easy measurement of two different applications simultaneously (for example, fluorescence and absorption measurement).



## Technical Data

<b>Wavelength range</b>	250-2000nm
<b>Throughput</b>	Ca. 25%
<b>Temperature range</b>	0-40 C
<b>Switching time open</b>	15 ms
<b>Switching time close</b>	30 ms
<b>Maximum frequency</b>	10 Hz
<b>Power supply</b>	5VDC, 0.3A (max power 1.5W)
<b>Fiber connection</b>	SMA-905 connector
<b>Material mechanical</b>	Black anodized aluminum
<b>Material optical</b>	UV Fused silica
<b>Dimensions (LxWxH)</b>	44 x 34 x 63 mm *
<b>Weight</b>	184 grams

## FULL PRODUCT SPECIFICATIONS

Want to know the full product specifications, gratings selection, resolution table, accessories options and ordering information? Click [here](#) or scan the QR code on the right



# In-Line Flow Cells

For in-line absorbance or fluorescence measurements, Avantes offers in-line flow cells. They are available for tubing diameters of 1/4, 1/2, and 1 inch. The flow cells consist of Swagelok union cross-tube fittings and two UV/VIS/NIR collimating lenses.

The optical path depends on the flow cell size: the 1/4" version has an optical path of 5 mm, the 1/2" of 10 mm, and the 1" version of 20 mm. They feature SMA-905 connectors for easy coupling to our wide range of fiber optic cables or bundles.

All flow cells have variable focusing to optimize light throughput over the spectral range.

All flow cells are also available in high-temperature configurations (up to 200°C). Special flow cells for gasses and liquids are also available and are designed to withstand pressures up to 100 bar.



## Technical Data

	¼" flow cell	½" flow cell	1" flow cell
<b>Optical path</b>	5 mm	10 mm	20 mm
<b>Sample volume</b>	62 µl	124 µl	248 µl
<b>Wavelength range</b>	200-2500 nm		
<b>Fiber connection</b>	2 x SMA-905 connectors		
<b>Collimating optics</b>	Plano Convex, focal length 8.7 mm		
<b>Max. Temperature</b>	80°C (HT version till 200°C available on request)		
<b>Max. Pressure</b>	10 bar (Special Gasflowcell up to 100 bar)		
<b>Material</b>	Stainless steel for the fitting, black anodized aluminum for the SMA-905 connectors		
<b>Overall dimensions</b>	55 x 45 x 15 mm	72 x 50 x 22 mm	98 x 60 x 38 mm

## FULL PRODUCT SPECIFICATIONS

Want to know the full product specifications, gratings selection, resolution table, accessories options and ordering information? Click **here** or scan the QR code on the right



# Micro Flow Cells

For in-line measurements of low liquid volumes, Avantes offers micro flow cells. The micro flow cells feature a Z-design and can easily be coupled to 1.5 mm PTFE tubing with 0.5 mm inner diameter. Typically these are used for absorption measurements and HPLC applications. Two special fiber-optic cables (FC part number terminating in FIA) are required for coupling with these micro flow cells. The special fiber-optic cable is the window for these flow cells.

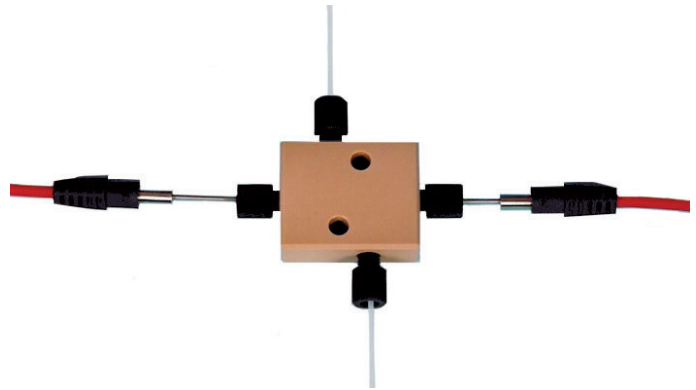

## Technical Data

Flow Cell Type	Micro flow Z-cell -10	Micro flow cell -1.5
Wavelength Range	200-2500 nm	
Optical path length	10 mm	1.5 mm
Sample volume	18 µl	3 µl
Tubing OD connection	1.5 mm (1/16")	
Pressure rating	10 bar	
Fiber-optic coupling	1.6 mm ferrule	
Dimensions / material	32 x 38 x 13 mm / PEEK	

## FULL PRODUCT SPECIFICATIONS

Want to know the full product specifications, gratings selection, resolution table, accessories options and ordering information? Click [here](#) or scan the QR code on the right



# Reference Tiles

For diffuse reflection measurements, Avantes offers the WS-2 reference tile. For specular reflection measurements, the RS-2 is available.

The WS-2 reference tile is made of a white diffuse PTFE-based material, considered the highest-grade reference material for diffuse reflectance. It is mostly used in colorimetric applications where a reference signal has to be obtained during a reflection measurement.

The PTFE material is high purity and processed using exacting standards to an amorphous structure, so the tile reflects light from 350-1800 nm at circa 98% and from 250-2500 nm at more than 92%. The material offers long-term stability, even in UV applications. The plastic is hydrophobic and chemically inert, so it is cleanable.

For gemology applications, the WS-2 is combined with a reflection integrating sphere. The gemstone is placed in the middle of the tile with the integrating sphere.

The special WS-2-GEM is designed to facilitate holding and cooling a gemstone with liquid nitrogen, as it features a cavity and hole in the middle of the tile.

The WS-2-CAL is a NIST traceable calibrated white reference tile that includes an electronic calibration file covering 250-2500 nm.

The RS-2 is a mirror tile that can be used as a reference standard for specular reflection measurements.

The RS-2-CAL is a calibrated mirror tile that includes a NIST traceable calibration file, which is created using an 8° absolute specular reflectance measurement over the wavelength range from 250-2500 nm.

We also have black and grey reference tiles available. These tiles are perfect for reflectance measurements. For more information on these tiles, please scan the QR code below to look at the ordering information on the product webpage.

## WS-2 and WS-2-GEM



## RS-2



### Technical Data

	WS-2	RS-2
<b>Material</b>	Diffuse PTFE material	BK7 with Al+MgF <sub>2</sub> coating
<b>Max. temperature</b>	280°C	80°C
<b>Dimensions tile</b>	32 mm diameter / 10 mm thick	32 mm diameter / 10 mm thick
<b>Housing</b>	38 mm diameter, black PVC, cover red anodized	

## FULL PRODUCT SPECIFICATIONS

Want to know the full product specifications, gratings selection, resolution table, accessories options and ordering information? Click [here](#) or scan the QR code on the right



# 12 and 24 Volts Power Adapters for Spectrometer and Light Sources

Most AvaSpec spectrometers are USB-powered, but some users prefer to power their instruments externally. Avantes PS-12V and PS-24V can be used to connect your AvaSpec spectrometer and AvaLight light sources to any 100-240V power connection.

The PS-12V has a maximum output of 1.0A and is used with all AvaSpec spectrometers and most light sources and accessories. The PS-24V is to be used with the AvaLight-HAL halogen light source and the FOS-inline fiber optic switch.

All power supplies are equipped with automatic thermal and overload cut-off circuitry. Please specify on the order which plug should be delivered based upon your geography: Euro, UK, USA, or Australian plugs are available.



## Technical Data

	PS-12V/1.0A	PS-24V/1.25A	PS-12V/2.08A
Power Input	100-240 VAC ± 10%/ 47-63 Hz		
Power consumption	400 mA	700 mA	
Power Output	12 VDC ± 5%, depending on load	24 VDC ± 5%, depending on load	12 VDC ± 5%, depending on load
Output current (max.)	1.0 A	1.25 A	2.08 A
DC –Connector	5.5 mm OD, 2.1 mm ID, 11.5 mm long	3.5 mm OD, 1.3 mm ID, 10 mm long	5.5 mm OD, 2.1 mm ID, 11.5 mm long
Dimensions	92 x 40 x 28 mm	105 x 68 x 39 mm	79 x 54 x 33 mm
Operating Temperature	0 - 45°C		
Cable length	2.0 m		1.25 m

## FULL PRODUCT SPECIFICATIONS

Want to know the full product specifications, gratings selection, resolution table, accessories options and ordering information? Click [here](#) or scan the QR code on the right



# WE ARE HAPPY TO HELP

Curious how our spectroscopy solutions can empower your application in-line, at your production facility, in the lab, or even in the field? Please visit our website or contact one of our technical engineers. We are happy to help you!



## Avantes Headquarters

Phone: +31 (0) 313 670 170  
Email: [info@avantes.com](mailto:info@avantes.com)  
Website: [www.avantes.com](http://www.avantes.com)



## Avantes USA

Phone: +1 (303) 410 866 8  
Email: [infousa@avantes.com](mailto:infousa@avantes.com)  
Website: [www.avantesusa.com](http://www.avantesusa.com)



## Avantes China

Phone: +86 (0) 108 457 404 5  
Email: [info@avantes.com.cn](mailto:info@avantes.com.cn)  
Website: [www.avantes.cn](http://www.avantes.cn)



## Avantes Newsletter

Never miss any product news, researches, applications notes and event information. Scan the QR code to sign-up for our monthly newsletter.

Follow us on social media:

